

TOTAL CABINET HARDWARE SOLUTIONS

HINGES CATCHES HANDLES

INDUSTRIAL AND MEDICAL

This is a revised copy of our print catalog. It represents our latest offering but our website is always most current and complete with

- * Latest new items and specifications
- * selection filters to find products fast
- * helpful design information
- * 2D drawings and 3D models

Click this box for GUDEN.COM



GUDEN

INDUSTRIAL HARDWARE MADE EASY

www.guden.com
800 3-HINGES • (631) 737-2900



CONTENTS

- 1** Introduction
- 5** Hinges
- 29** Military Hardware
- 33** Handles & Pulls
- 39** Catches and Glides
- 43** Sales Terms & Conditions



Hinge and Hardware Expertise. Exactly When You Need It.

Providing for the hardware needs of customers like you – that's been our sole focus for more than four generations.

We regularly incorporate new technologies, new resources and new capacities not only to meet your needs today, but also to anticipate your needs tomorrow. That's how we ensure your satisfaction each time you consider us.

You'll always have access to personal service and the latest technologies at Guden.

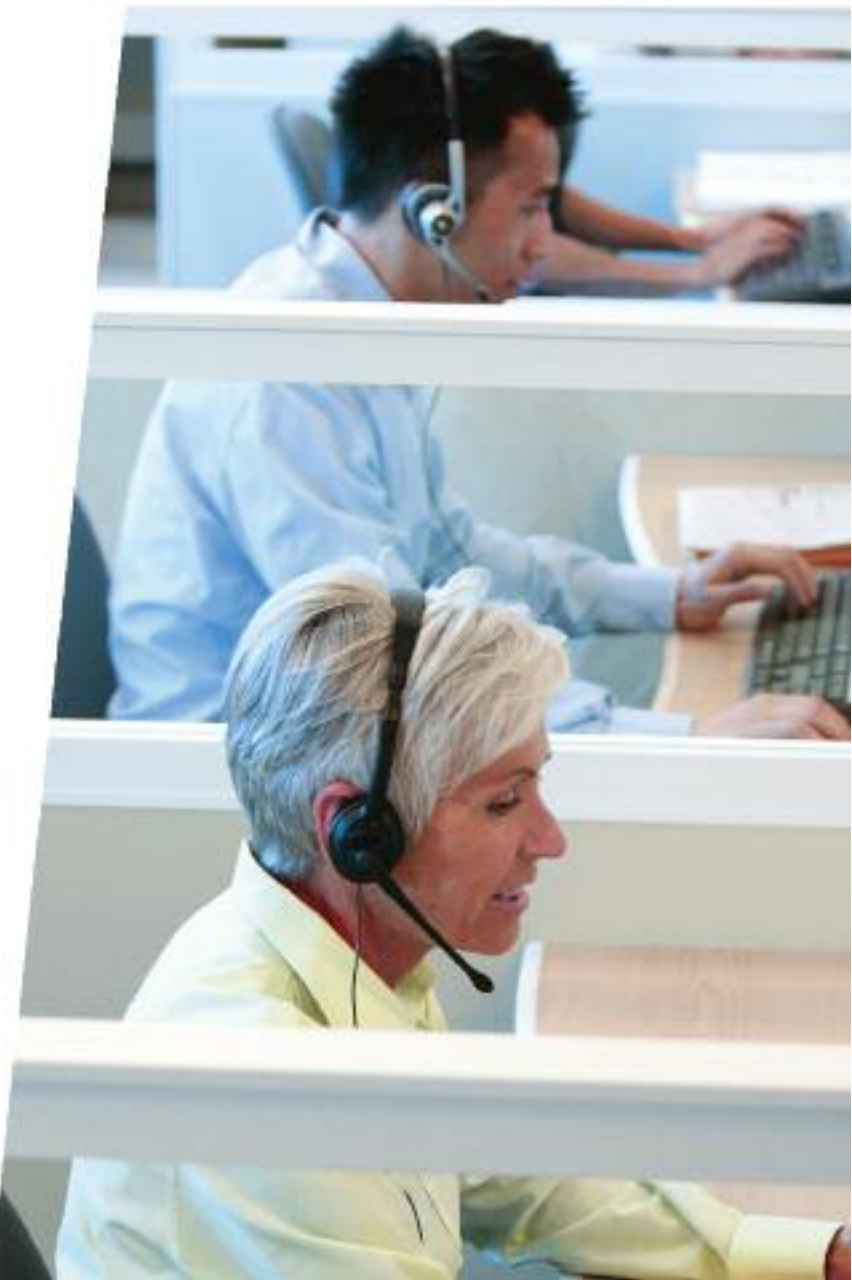

A Broad Line

Building on our heritage as a hinge expert, we



Tap Into a Full Selection of Ready-to-Ship Products

To meet all your hardware needs, we carry an enormous supply of stock products in a wide variety of materials and finishes. And with our automated inventory management and product replenishment systems, we can accommodate demanding schedules and delivery requirements.

The Personal Service You Deserve

However you want to work with us, we're ready. From online web help to expert telephone support, from e-mail and fax response to in-person consultations, a Guden representative will always be available to help you.

Whatever your hardware specifications, count on a Guden expert to work with you every step of the way.

of Hardware

support all your cabinet, lid and door solutions.



The Assurance of an ISO 9000 Compliant Quality System

With our ISO 9000 compliance, you know that our quality will always be at its highest. It's your assurance that our products will meet your exact specifications.

Guden Goes Social

As times and technologies change, so do means of communication. The advent of social media is allowing us to provide a more open and interactive dialogue with you, our customer.



Highly trained customer service reps offer you broad expertise and extended personal service.

Customized Product Solutions

You have a project that requires some customization assistance. One of our **Custom Products Group** representatives is immediately assigned to be your sole contact and project coordinator. After reviewing the design, we will recommend either modifying it to work with a Guden stock product, customize a stock part to suit, or develop a unique custom product. Whichever the case, our goal is to provide you with a quality solution that is both optimized and cost-effective.

These are just some of the ways we're doing whatever it takes to meet your hardware needs. And as your hardware requirements change, we'll continue to expand and adapt to meet them.

Because at H. A. Guden Co., Inc., our sole business is serving your business.



Visit us at www.guden.com for our online catalog.

CONTINUOUS BUTT WELD-ON LATCH UN-

HING COVER



HINGES

Continuous • Butt • Specialty

CONTENTS

6	Hinge Nomenclature	14	Polished Stainless w/holes	19	Latch Hinges	26	Strap / T-Hinges
8	Continuous Hinges	15	Preplated Steel w/holes	20	Un-Hinges	27	Bifold Screen Door Hinges
14	316 STS Hinges	15	Stop Hinges	21	Invisible Hinges	27	Cover Hinges
14	Electrogalvanized Hinges	16	Butt Hinges	22	Slip Joint Hinges	27	Spring Hinges
14	Raw Brass	18	Weld-on Hinges	24	Low-Cost Slip Joint Hinges		
		19	Concealed Hinges	26	Flag Hinges		

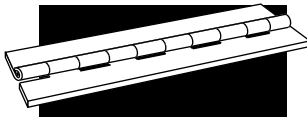

HINGE NOMENCLATURE

NOMENCLATURE

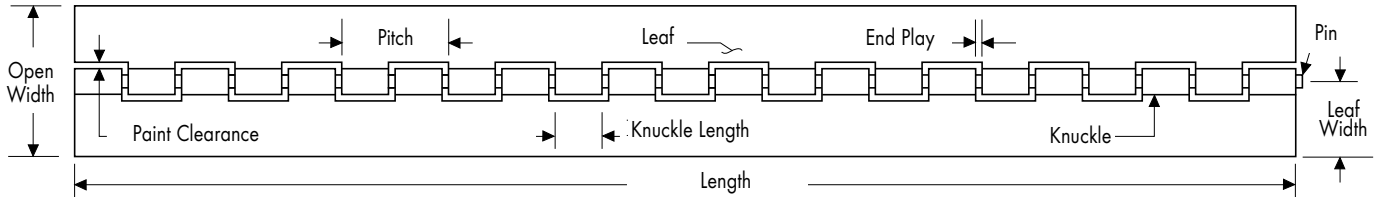

Length

The length of the leaves measured parallel to the pin.

Open Width

The overall dimension of the leaves measured perpendicular, or across the pin.

Leaf

That portion of a hinge extending laterally from the knuckle, which generally revolves around a pin.

Leaf Width

The dimension from the center of the pin to the outer edge of the leaf.

Paint Clearance

The dimension between the outer face of the knuckle and the opposing edge of the leaf cutout over the entire range of rotation.

End Play

The amount of axial movement between the leaves.

Knuckle Length

The typical dimension of the knuckle measured parallel to the pin.

Pitch

The dimension from a point on the knuckle to the same point on an adjacent knuckle on the same leaf.

Knuckle

The hollow circular part at the knuckle of a hinge through which a pin is passed. (Sometimes called loop, joint, node or curl.)

Pin

Rod running the length of the hinge. The pin holds the leaves of the hinge together.

Side Play

The amount of movement of the leaves perpendicular to the pin.

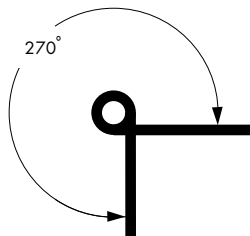

Open (or Back Angle)

Leaves are opened through the maximum arc, usually about 270°. This varies from series to series and can be adjusted for special applications.

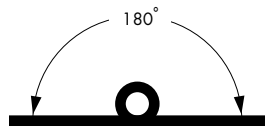

Flat

Leaves are parallel, and at the 180° position.



Closed

Leaves are parallel, together and at the 0° position.

SWAGING



Fig. 1

Hinge with both leaves not swaged - our "plain" or standard assembly



Fig. 2

Hinge with both leaves half swaged



Fig. 3

Hinge with one leaf half swaged



Fig. 4

Hinge with one leaf full swaged



Fig. 5

Swage for reverse assembly



Fig. 6

Reverse assembly

ABBREVIATIONS

Material	Abbreviation
Plain Steel or Cold Rolled Steel	PS
Stainless Steel (Type 302/304)	STS or SS
Steel Brass Pin	PB
Stainless Steel (Type 316)	TS
Aluminum / Aluminum Pin	AA
Aluminum with Stainless Pin	AS
Raw Brass	BR
Polished Stainless	SP
Prefinished Brass on Steel	FB
Prefinished Nickel on Steel	FN
Prefinished Electrogalvanized on Steel	EG

Hand Codes

Right Hand	RH or R
Left Hand	LH or L
Reversible	RV

Holes

No Holes	NH
With Holes	WH

FINISH CODES

Digits and letters after the hyphen indicate the finish code

02	Commercial Zinc
02B	Black Zinc
03	Bright Brass
04	Satin (Dull) Brass
1B	Black Powdercoat
14	Bright Nickel
15	Satin (Dull) Nickel
20	Statuary Bronze
26	Bright Chrome
26D	Satin (Dull) Chrome
28	Aluminum, Caustic Etched
28A	Aluminum, Satin and Clear Anodized
28B	Aluminum, Satin and Lacquered
28C	Aluminum, Anodized and Brite Dip
32	Stainless, No Finish
32B	Stainless Steel, Burnished
32D	Stainless Steel, Satin

PIN

The pin or rod that holds hinge leaves together may be furnished in several ways depending on the application. Some pins are easily removed; others are permanently mounted. Several variations are illustrated here.

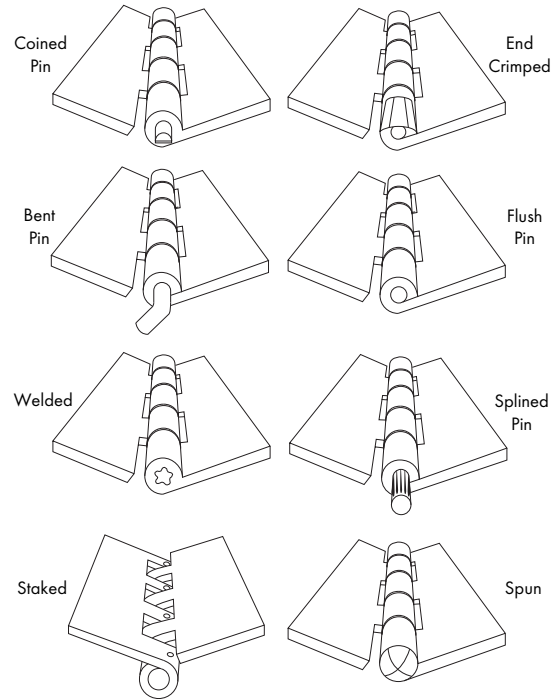

COMPARISON OF GAUGES & DECIMAL EQUIVALENTS FOR PLAIN STEEL AND STAINLESS STEEL

Gauge No.	U.S. Standard	Gauge No.	U.S. Standard
7	.1875	17	.05625
8	.171875	18	.05
9	.15625	19	.04375
10	.140625	20	.0375
11	.125	21	.034375
12	.109375	22	.03125
13	.09375	23	.028125
14	.078125	24	.025
15	.0703125	25	.021875
16	.0625	26	.01875

AVAILABLE ALUMINUM THICKNESSES

.020	.040	.075	.100	.190
.025	.050	.080	.120	.249
.032	.060	.090	.160	

Note: All dimensions in this catalog are in inches.

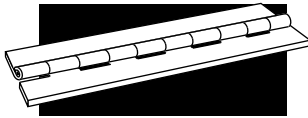

CONTINUOUS HINGES



STAINLESS, STEEL AND ALUMINUM

Leaf Thick. .025 Pin Dia. .062 Knuckle .25

Open Width	Part Numbers				Length
	SS Leaf & Pin	Steel Leaf & Pin	Alum w/Alum Pin	Alum w/SS Pin	
.75	SS02030202*	PS02030202*	AA02030202*	AS02030202*	72
1.00	SS02030203*	PS02030203*	AA02030203*	AS02030203*	
1.25	SS02030205	PS02030205	CALL US	CALL US	
1.50	SS02030206	PS02030206	CALL US	AS02030206*	

Leaf Thick. .025 Pin Dia. .062 Knuckle .50

Open Width	Part Numbers				Length
	SS Leaf & Pin	Steel Leaf & Pin	Alum w/Alum Pin	Alum w/SS Pin	
.50	SS02030401	PS02030401	CALL US	CALL US	72
.75	SS02030402	PS02030402	CALL US	CALL US	

Leaf Thick. .032 Pin Dia. .062 Knuckle .50

Open Width	Part Numbers				Length
	SS Leaf & Pin	Steel Leaf & Pin	Alum w/Alum Pin	Alum w/SS Pin	
.75	SS03030402	PS03030402	AA03030402	AS03030402	72
1.00	SS03030403	PS03030403	AA03030403	CALL US	
1.06	SS03030404	PS03030404	AA03030404	AS03030404	
1.25	SS03030405	PS03030405	AA03030405	AS03030405	
1.50	SS03030406	PS03030406	AA03030406	CALL US	

Leaf Thick. .032 Pin Dia. .091 Knuckle .25

Open Width	Part Numbers				Length
	SS Leaf & Pin	Steel Leaf & Pin	Alum w/Alum Pin	Alum w/SS Pin	
.75	CALL US	CALL US	AA03050202	AS03050202	72
1.06	CALL US	CALL US	AA03050204	AS03050204	
1.25	CALL US	CALL US	AA03050205	AS03050205	
1.50	CALL US	CALL US	AA03050206	AS03050206	

MORE LENGTHS

Additional lengths and custom sizes are also available. Visit www.guden.com or call us for quotes and availability.

Now to complete Part No. add length:
Ex: PS03030402 - 72

Leaf Thick. .035 Pin Dia. .086 Knuckle .25

Open Width	Part Numbers				Length
	SS Leaf & Pin	Steel Leaf & Pin	Alum w/Alum Pin	Alum w/SS Pin	
.75	SS04040202*	PS04040202*	CALL US	CALL US	72
1.06	SS04040204*	PS04040204*	CALL US	CALL US	
1.25	SS04040205*	PS04040205*	CALL US	CALL US	
1.50	SS04040206*	PS04040206*	CALL US	CALL US	
2.00	SS04040208*	PS04040208*	CALL US	CALL US	



STAINLESS, STEEL AND ALUMINUM (cont.)

Leaf Thick. .040 Pin Dia. .091 Knuckle .50

Open Width	Part Numbers				Length
	SS Leaf & Pin	Steel Leaf & Pin	Alum w/Alum Pin	Alum w/SS Pin	
1.06	SS05050404	PS05050404**	AA05050404	AS05050404	72
1.25	SS05050405	PS05050405**	AA05050405	AS05050405	
1.50	SS05050406	PS05050406**	AA05050406	AS05050406	
2.00	SS05050408	PS05050408**	AA05050408	AS05050408	
2.50	SS05050409	PS05050409**	CALL US	CALL US	
3.00	SS05050410	PS05050410**	CALL US	CALL US	

Leaf Thick. .040 Pin Dia. .091 Knuckle .625

Open Width	Part Numbers				Length
	SS Leaf & Pin	Steel Leaf & Pin	Alum w/Alum Pin	Alum w/SS Pin	
1.06	SS05050504 [†]	PS05050504 [†]	AA05050504 [†]	AS05050504 [†]	72.50
1.25	SS05050505 [†]	PS05050505 [†]	AA05050505 [†]	AS05050505 [†]	
1.50	SS05050506 [†]	PS05050506 [†]	AA05050506 [†]	AS05050506 [†]	
2.00	SS05050508 [†]	PS05050508 [†]	AA05050508 [†]	AS05050508 [†]	

Leaf Thick. .050 Pin Dia. .120 Knuckle .50

Open Width	Part Numbers				Length
	SS Leaf & Pin	Steel Leaf & Pin	Alum w/Alum Pin	Alum w/SS Pin	
1.06	SS06060404	PS06060404	AA06060404	AS06060404	72
1.25	SS06060405	PS06060405	AA06060405	AS06060405	
1.50	SS06060406	PS06060406	AA06060406	AS06060406	
2.00	SS06060408	PS06060408	AA06060408	AS06060408	
2.50	SS06060409	PS06060409	AA06060409	AS06060409	
3.00	SS06060410	PS06060410	AA06060410	AS06060410	
4.00	SS06060411	PS06060411	AA06060411	AS06060411	

Leaf Thick. .050 Pin Dia. .120 Knuckle .625

Open Width	Part Numbers				Length
	SS Leaf & Pin	Steel Leaf & Pin	Alum w/Alum Pin	Alum w/SS Pin	
1.06	SS06060504	PS06060504	AA05050504*	AS05050504*	85
1.25	SS06060505	PS06060505	AA06060505*	AS06060505*	
1.50	SS06060506	PS06060506	AA06060506*	AS06060506*	
2.00	SS06060508	PS06060508	AA06060508*	AS06060508*	
2.50	SS06060509	PS06060509	AA06060509*	AS06060509*	
3.00	SS06060510	PS06060510	AA06060510*	AS06060510*	



MORE LENGTHS

Additional lengths and custom sizes are also available. Visit www.guden.com or call us for quotes and availability.

Now to complete Part No. add length:
Ex: PS03030402 - 72

** Available from stock with Brass Pin - Specify "PB" instead of "PS" as part number prefix.

[†] Part number suffix will be -72

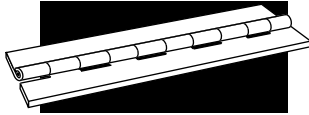

CONTINUOUS HINGES



STAINLESS, STEEL AND ALUMINUM



Leaf Thick. .060 Pin Dia. .120 Knuckle .50

Open Width	Part Numbers				Length
	SS Leaf & Pin	Steel Leaf & Pin	Alum w/Alum Pin	Alum w/SS Pin	
1.06	SS07060404	PS07060404	AA07060404	AS07060404	84
1.25	SS07060405	PS07060405	AA07060405	AS07060405	
1.50	SS07060406	PS07060406	AA07060406	AS07060406	
2.00	SS07060408	PS07060408	AA07060408	AS07060408	
2.50	SS07060409	PS07060409	AA07060409	AS07060409	
3.00	SS07060410	PS07060410	AA07060410	AS07060410	
4.00	SS07060411	PS07060411	AA07060411	AS07060411	

Leaf Thick. .060 Pin Dia. .120 Knuckle .625

Open Width	Part Numbers				Length
	SS Leaf & Pin	Steel Leaf & Pin	Alum w/Alum Pin	Alum w/SS Pin	
1.06	SS07060504	PS07060504	AA07060504	AS07060504	85
1.25	SS07060505	PS07060505	AA07060505	AS07060505	
1.50	SS07060506	PS07060506	AA07060506	AS07060506	
2.00	SS07060508	PS07060508	AA07060508	AS07060508	
2.50	SS07060509	PS07060509	AA07060509	AS07060509	
3.00	SS07060510	PS07060510	AA07060510	AS07060510	
4.00	SS07060511	PS07060511	CALL US	CALL US	

Leaf Thick. .060 Pin Dia. .120 Knuckle .75

Open Width	Part Numbers				Length
	SS Leaf & Pin	Steel Leaf & Pin	Alum w/Alum Pin	Alum w/SS Pin	
1.06	SS07060604	PS07060604	CALL US	CALL US	72
1.25	SS07060605	PS07060605	CALL US	CALL US	
1.50	SS07060606	PS07060606	CALL US	CALL US	
2.00	SS07060608	PS07060608	CALL US	CALL US	
2.50	SS07060609	PS07060609	CALL US	CALL US	
3.00	SS07060610	PS07060610	CALL US	CALL US	
4.00	SS07060611	PS07060611	CALL US	CALL US	

MORE LENGTHS

Additional lengths and custom sizes are also available. Visit www.guden.com or call us for quotes and availability.

Now to complete Part No. add length:
Ex: PS03030402 - 72

Leaf Thick. .060 Pin Dia. .120 Knuckle 1.00

Open Width	Part Numbers				Length
	SS Leaf & Pin	Steel Leaf & Pin	Alum w/Alum Pin	Alum w/SS Pin	
1.06	SS07060704	PS07060704**	AA07060704	AS07060704	84
1.25	SS07060705	PS07060705**	AA07060705	AS07060705	
1.50	SS07060706	PS07060706**	AA07060706	AS07060706	
2.00	SS07060708	PS07060708**	AA07060708	AS07060708	
2.50	SS07060709	PS07060709**	AA07060709	AS07060709	
3.00	SS07060710	PS07060710**	AA07060710	AS07060710	
4.00	SS07060711	PS07060711**	AA07060711	AS07060711	

** Available from stock with Brass Pin - Specify "PB" instead of "PS" as part number prefix.



STAINLESS, STEEL AND ALUMINUM (cont.)

Leaf Thick. .060 Pin Dia. .187 Knuckle .625

Open Width	Part Numbers				
	SS Leaf & Pin	Steel Leaf & Pin	Alum w/Alum Pin	Alum w/SS Pin	Length
1.50	SS07070506 [†]	PS07070506 [†]	CALL US	CALL US	72.50
2.00	SS07070508 [†]	PS07070508 [†]	AA07070508 [†]	AS07070508 [†]	
2.50	SS07070509 [†]	PS07070509 [†]	AA07070509 [†]	AS07070509 [†]	
3.00	SS07070510 [†]	PS07070510 [†]	AA07070510 [†]	AS07070510 [†]	
4.00	CALL US	CALL US	AA07070511 [†]	AS07070511 [†]	

Leaf Thick. .060 Pin Dia. .187 Knuckle 1.00

Open Width	Part Numbers				
	SS Leaf & Pin	Steel Leaf & Pin	Alum w/Alum Pin	Alum w/SS Pin	Length
1.06	SS07070704	PS07070704	AA07070704	AS07070704	84
1.25	SS07070705	PS07070705	AA07070705	AS07070705	
1.50	SS07070706	PS07070706	AA07070706	AS07070706	
2.00	SS07070708	PS07070708	AA07070708	AS07070708	
2.50	SS07070709	PS07070709	AA07070709	AS07070709	
3.00	SS07070710	PS07070710	AA07070710	AS07070710	
4.00	SS07070711	PS07070711	CALL US	CALL US	

Leaf Thick. .060 Pin Dia. .187 Knuckle 2.00

Open Width	Part Numbers				
	SS Leaf & Pin	Steel Leaf & Pin	Alum w/Alum Pin	Alum w/SS Pin	Length
1.06	CALL US	CALL US	AA07070804	AS07070804	84
1.25	CALL US	CALL US	AA07070805	AS07070805	
1.50	SS07070806	PS07070806	AA07070806	AS07070806	
2.00	SS07070808	PS07070808	AA07070808	AS07070808	
2.50	SS07070809	PS07070809	AA07070809	AS07070809	
3.00	SS07070810	PS07070810	AA07070810	AS07070810	

Leaf Thick. .072 Pin Dia. .187 Knuckle .50

Open Width	Part Numbers				
	SS Leaf & Pin	Steel Leaf & Pin	Alum w/Alum Pin	Alum w/SS Pin	Length
1.06	SS08070404	PS08070404	CALL US	CALL US	84
1.25	SS08070405	PS08070405	CALL US	CALL US	
1.50	SS08070406	PS08070406	CALL US	CALL US	
2.00	SS08070408	PS08070408	AA08070408	AS08070408	
2.50	SS08070409	PS08070409	AA08070409	AS08070409	
3.00	SS08070410	PS08070410	AA08070410	AS08070410	
4.00	SS08070411	PS08070411	AA08070411	AS08070411	



MORE LENGTHS

Additional lengths and custom sizes are also available. Visit www.guden.com or call us for quotes and availability.

Now to complete Part No. add length:
Ex: PS03030402 - 72

[†] Part number suffix will be -72

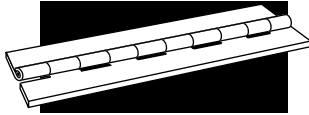

CONTINUOUS HINGES



STAINLESS, STEEL AND ALUMINUM



Leaf Thick. .075 Pin Dia. .187 Knuckle 2.00

Open Width	Part Numbers				
	SS Leaf & Pin	Steel Leaf & Pin	Alum w/Alum Pin	Alum w/SS Pin	Length
2.00	SS08070808	PS08070808	AA08070808	AS08070808	84
2.50	SS08070809	PS08070809	AA08070809	AS08070809	
3.00	SS08070810	PS08070810	AA08070810	AS08070810	
4.00	SS08070811	PS08070811	AA08070811	AS08070811	

Leaf Thick. .075 Pin Dia. .250 Knuckle 1.00

Open Width	Part Numbers				
	SS Leaf & Pin	Steel Leaf & Pin	Alum w/Alum Pin	Alum w/SS Pin	Length
2.00	SS08080708	PS08080708	CALL US	CALL US	72
2.50	SS08080709	PS08080709	CALL US	CALL US	
3.00	SS08080710	PS08080710	CALL US	CALL US	
4.00	SS08080711	PS08080711	CALL US	CALL US	
5.00	SS08080712	PS08080712	CALL US	CALL US	

Leaf Thick. .075 Pin Dia. .250 Knuckle 2.00

Open Width	Part Numbers				
	SS Leaf & Pin	Steel Leaf & Pin	Alum w/Alum Pin	Alum w/SS Pin	Length
2.00	SS08080808	PS08080808	AA08080808	AS08080808	84
2.50	SS08080809	PS08080809	AA08080809	AS08080809	
3.00	SS08080810	PS08080810	AA08080810	AS08080810	
4.00	SS08080811	PS08080811	AA08080811	AS08080811	
5.00	SS08080812	PS08080812	CALL US	CALL US	
6.00	SS08080813	PS08080813	CALL US	CALL US	

Leaf Thick. .090 Pin Dia. .187 Knuckle 2.00

Open Width	Part Numbers				
	SS Leaf & Pin	Steel Leaf & Pin	Alum w/Alum Pin	Alum w/SS Pin	Length
2.00	SS09070808	PS09070808	CALL US	CALL US	72
2.50	SS09070809	PS09070809	CALL US	CALL US	
3.00	SS09070810	PS09070810	CALL US	CALL US	
4.00	SS09070811	PS09070811	CALL US	CALL US	
5.00	SS09070812	PS09070812	CALL US	CALL US	
6.00	SS09070813	PS09070813	CALL US	CALL US	

Leaf Thick. .090 Pin Dia. .250 Knuckle 1.00

Open Width	Part Numbers				
	SS Leaf & Pin	Steel Leaf & Pin	Alum w/Alum Pin	Alum w/SS Pin	Length
2.00	SS09080708	PS09080708	CALL US	CALL US	72
2.50	SS09080709	PS09080709	CALL US	CALL US	
3.00	SS09080710	PS09080710	CALL US	CALL US	
4.00	SS09080711	PS09080711	CALL US	CALL US	

MORE LENGTHS

Additional lengths and custom sizes are also available. Visit www.guden.com or call us for quotes and availability.

Now to complete Part No. add length:
Ex: PS03030402 - 72



STAINLESS, STEEL AND ALUMINUM (cont.)

Leaf Thick. .090 Pin Dia. .250 Knuckle 2.00

Part Numbers					
Open Width	SS Leaf & Pin	Steel Leaf & Pin	Alum w/Alum Pin	Alum w/SS Pin	Length
2.00	SS09080808	PS09080808	CALL US	CALL US	84
2.50	SS09080809	PS09080809	CALL US	CALL US	
3.00	SS09080810	PS09080810	AA09080810	AS09080810	
4.00	SS09080811	PS09080811	AA09080811	AS09080811	
5.00	SS09080812	PS09080812	AA09080812	AS09080812	
6.00	SS09080813	PS09080813	CALL US	CALL US	

Leaf Thick. .120 Pin Dia. .250 Knuckle 2.00

Part Numbers					
Open Width	SS Leaf & Pin	Steel Leaf & Pin	Alum w/Alum Pin	Alum w/SS Pin	Length
2.00	SS10080808	PS10080808	AA10080808	AS10080808	72
2.50	SS10080809	PS10080809	CALL US	CALL US	
3.00	SS10080810	PS10080810	AA10080810	AS10080810	
4.00	SS10080811	PS10080811	AA10080811	AS10080811	
5.00	SS10080812	PS10080812	CALL US	CALL US	
6.00	SS10080813	PS10080813	CALL US	CALL US	

Leaf Thick. .120 Pin Dia. .375 Knuckle 2.00

Part Numbers					
Open Width	SS Leaf & Pin	Steel Leaf & Pin	Alum w/Alum Pin	Alum w/SS Pin	Length
2.00	SS10090808	PS10090808	CALL US	CALL US	84
2.50	SS10090809	PS10090809	CALL US	CALL US	
3.00	SS10090810	PS10090810	CALL US	CALL US	
4.00	SS10090811	PS10090811	AA10090811	AS10090811*	
5.00	SS10090812	PS10090812	AA10090812	AS10090812*	
6.00	SS10090813	PS10090813	AA10090813	AS10090813*	

Leaf Thick. .179 Pin Dia. .500 Knuckle 2.00

Part Numbers					
Open Width	SS Leaf & Pin	Steel Leaf & Pin	Alum w/Alum Pin	Alum w/SS Pin	Length
3.00	SS11100810	PS11100810	CALL US	CALL US	96
5.00	SS11100812	PS11100812	CALL US	CALL US	

Leaf Thick. .250 Pin Dia. .625 Knuckle 1.50

Part Numbers					
Open Width	SS Leaf & Pin	Steel Leaf & Pin	Alum w/Alum Pin	Alum w/SS Pin	Length
3.00	SS12111010	PS12111010	CALL US	CALL US	72
5.00	SS12111012	PS12111012	CALL US	CALL US	



MORE LENGTHS

Additional lengths and custom sizes are also available. Visit www.guden.com or call us for quotes and availability.

Now to complete Part No. add length:
Ex: PS03030402 - 72

* 96 not available from stock

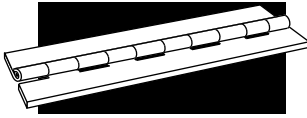

CONTINUOUS HINGES



TYPE 316 STAINLESS STEEL



Leaf Thick. .040 Pin Dia. .091 Knuckle .50

Open Width	Part Numbers	Length
1.06	TS05050404	72
1.25	TS05050405	
1.50	TS05050406	
2.00	TS05050408	

Leaf Thick. .060 Pin Dia. .120 Knuckle .50

Open Width	Part Numbers	Length
1.50	TS07060406	72
2.00	TS07060408	
2.50	TS07060409	
3.00	TS07060410	

STEEL / ELECTROGALVANIZED

Leaf Thick. .042 Pin Dia. .091 Knuckle .50

Open Width	Part Numbers	Length
1.50	EG05050406	72
2.00	EG05050408	

Leaf Thick. .060 Pin Dia. .120 Knuckle .50

Open Width	Part Numbers	Length
1.50	EG07060406	72
2.00	EG07060408	
3.00	EG07060410	

MORE LENGTHS

Additional lengths and custom sizes are also available. Visit www.guden.com or call us for quotes and availability.

Now to complete Part No. add length:
Ex: PS03030402 - 72

* These items are normally supplied with pins staked in place.



POLISHED STAINLESS WITH HOLES – ON 2" CENTERS

Leaf Thick. .040 Pin Dia. .091 Knuckle .50

Open Width	Part Numbers	Hole Diameter	Length
1.06	SPO5050404*	#5 ctsk	72
1.25	SPO5050405*	#5 ctsk	
1.50	SPO5050406*	#6 ctsk	
2.00	SPO5050408*	#6 ctsk	

Leaf Thick. .060 Pin Dia. .120 Knuckle .50

Open Width	Part Numbers	Hole Diameter	Length
1.50	SPO7060406*	#6 ctsk	72
2.00	SPO7060408*	#6 ctsk	
3.00	SPO7060410*	#6 ctsk	



PREPLATED STEEL HINGES WITH HOLES – ON 2" CENTERS

Leaf Thick. .040 Pin Dia. .091 Knuckle .50

Open Width	Part Numbers		Hole Diameter	Stock Length
	Steel/Nickel	Steel/Brass		
1.06	FN05050404*	FB05050404*	#4 ctsk	72
1.25	FN05050405*	FB05050405*	#4 ctsk	
1.50	FN05050406*	FB05050406*	#4 ctsk	
2.00	FN05050408*	FB05050408*	#6 ctsk	

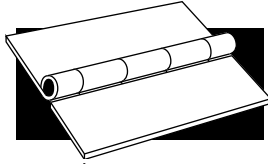

BUTT HINGES

Made in USA



SERIES 1000 - TYPE 304 STAINLESS STEEL (Pin spun on both ends, no holes, no finish)

Length	Open Width	Leaf Thickness	Pin Diameter	Part No.
2.00	1.50	.060	.120	1000200150612
3.00	2.00	.090	.187	1000300200918
3.00	2.00	.120	.250	1000300201225
3.50	3.00	.090	.187	1000350300918
4.00	3.00	.120	.250	1000400301225

SERIES 2000 - TYPE 316 STAINLESS STEEL (No holes, square butts, pin spun on both ends)

Length	Open Width	Leaf Thickness	Pin Diameter	Part No.
2.00	2.00	.075	.187	2000200718
3.00	3.00	.090	.187	2000300918
3.00	3.00	.120	.250	2000301225
4.00	4.00	.120	.250	2000401225

SERIES 3000 - PLAIN STEEL (No holes, cutoffs, staked pin)

Length	Open Width	Leaf Thickness	Pin Diameter	Part No.
.75	.75	.035	.086	300007070308
1.00	1.06	.035	.086	300010100308
1.25	1.06	.035	.086	300012100308
1.50	1.06	.035	.086	300015100308
1.50	1.50	.035	.086	300015150308
2.00	1.06	.035	.086	300020100308
2.00	1.50	.035	.086	300020150308
2.00	2.00	.035	.086	300020200308

SERIES 4000 - PLAIN STEEL (No holes, pin headed one end only)

Length	Open Width	Leaf Thickness	Pin Diameter	Part No.
1.50	1.50	.055	.120	400015150512
2.00	1.50	.060	.120	400020150612
2.00	2.00	.060	.120	400020200612
2.50	2.50	.078	.187	400025250718
4.00	3.83	.093	.250	400040380925

SERIES 5000 - PLAIN STEEL (No holes, rectangular butts, pin spun on both ends)

Length	Open Width	Leaf Thickness	Pin Diameter	Part No.
1.50	1.31	.050	.120	500015130512
2.00	1.50	.060	.120	500020150612
2.50	1.50	.060	.120	500025150612

SERIES 6000 - PLAIN STEEL (No holes, square butts, pin spun on both ends)

Length	Open Width	Leaf Thickness	Pin Diameter	Part No.
1.50	1.50	.050	.120	6000150512
2.00	2.00	.060	.120	6000200612
2.00	2.00	.078	.187	6000200718
2.50	2.50	.060	.120	6000250612
2.50	2.50	.078	.187	6000250718
2.50	2.50	.125	.250	6000251225
3.00	3.00	.060	.120	6000300612
3.00	3.00	.078	.187	6000300718
3.00	3.00	.093	.250	6000300925
3.00	3.00	.125	.250	6000301225
4.00	4.00	.075	.187	6000400718
4.00	4.00	.125	.250	6000401225
5.00	5.00	.125	.250	6000501225
6.00	6.00	.125	.250	6000601225
6.00	6.00	.187	.500	6000601850



SERIES 7000 - STAINLESS STEEL (No holes, square butts, stainless pin spun on both ends)

Length	Open Width	Leaf Thickness	Pin Diameter	Part No.
1.00	1.06	.035	.086	7000100308*
1.50	1.50	.035	.086	7000150308*
1.50	1.50	.050	.120	7000150512
2.00	2.00	.060	.120	7000200612
2.00	2.00	.078	.187	7000200718
2.50	2.50	.060	.120	7000250612
2.50	2.50	.078	.187	7000250718
3.00	3.00	.060	.120	7000300612
3.00	3.00	.078	.187	7000300718
3.00	3.00	.090	.187	7000300918
3.00	3.00	.093	.250	7000300925
3.00	3.00	.125	.250	7000301225
4.00	4.00	.078	.187	7000400718
4.00	4.00	.125	.250	7000401225
4.00	4.00	.125	.375	7000401237
5.00	5.00	.125	.250	7000501225
6.00	6.00	.125	.250	7000601225
6.00	6.00	.165	.375	7000601637

SERIES 8000 - STAINLESS STEEL (Holes, stainless pin spun on both ends, no finish)

Length	Open Width	Leaf Thickness	Pin Diameter	Part No.
1.50	1.50	.035	.086	8000150308*
1.50	1.50	.050	.120	8000150512
2.00	2.00	.060	.120	8000200612
2.00	2.00	.078	.187	8000200718
2.50	2.50	.060	.120	8000250612
2.50	2.50	.078	.187	8000250718
3.00	3.00	.060	.120	8000300612
3.00	3.00	.078	.187	8000300718
3.00	3.00	.093	.250	8000300925
3.00	3.00	.125	.250	8000301225
4.00	4.00	.078	.187	8000400718
4.00	4.00	.125	.250	8000401225
5.00	5.00	.125	.250	8000501225
6.00	6.00	.125	.250	8000601225

SERIES 9000 - ALUMINUM (No holes, square butts, stainless steel pin spun on both ends)

Length	Open Width	Leaf Thickness	Pin Diameter	Part No.
1.00	1.06	.040	.080	9000100408**
1.50	1.50	.050	.120	9000150512
2.00	2.00	.060	.120	9000200612
2.00	2.00	.078	.187	9000200718
2.50	2.50	.060	.120	9000250612
2.50	2.50	.078	.187	9000250718
3.00	3.00	.060	.120	9000300612
3.00	3.00	.078	.187	9000300718
3.00	3.00	.090	.250	9000300925
3.00	3.00	.125	.250	9000301225
4.00	4.00	.125	.250	9000401225

* Cut-off, pin staked in place.

** Cut-off, aluminum pin, staked in place.

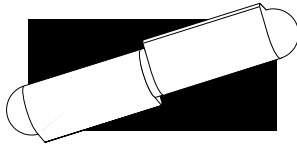

WELD-ON HINGES

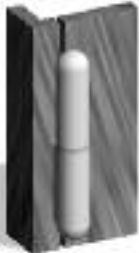

Weld-On Hinges are well suited for flush construction.



Weld-On Hinges work well in overlapping construction.



Weld-On Hinges are well suited for gate construction.

The Guden Weld-On Hinge is an attractive new alternative for your hinge needs. It offers continuous, smooth operation and eliminates the need for unsightly fasteners and leaves.

The Weld-On Hinge is ideal for a wide range of applications, everything from electrical and tool boxes to machinery doors and air-conditioning enclosures.

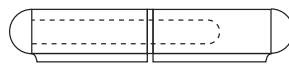
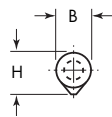
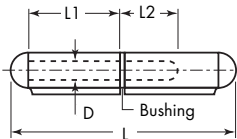
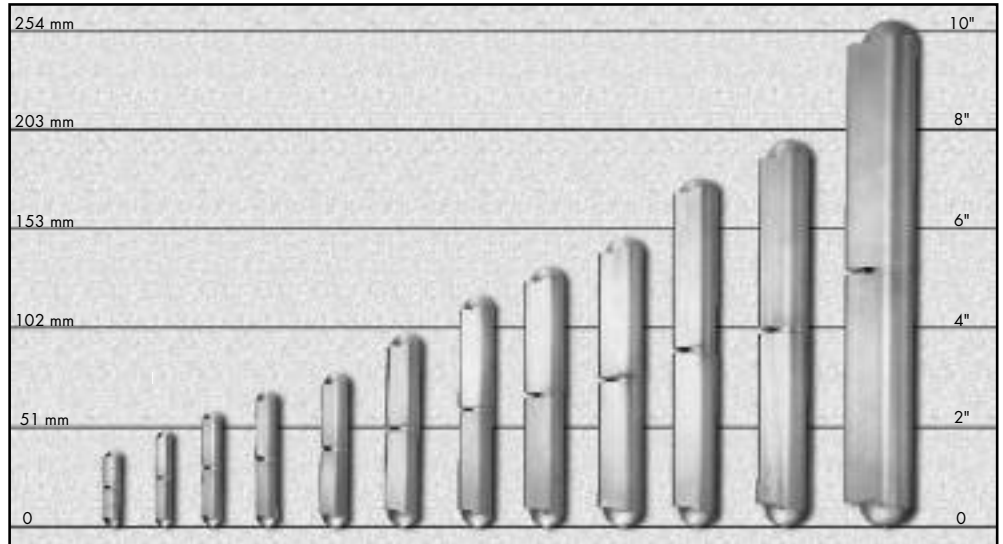

Fixed Pin

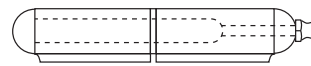

Fixed Pin with Grease Fitting

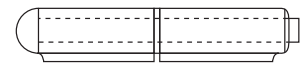

Removable Pin

Steel/ steel pin	Steel/ brass pin	Steel/steel pin grease fitting	Steel/brass pin grease fitting	Steel/STS pin grease fitting	Steel/steel loose pin	LengthThk. Dia.			Pin Dia.					
						Stainless	Alum./STS pin	Steel/STS pin	L	H	B	L1	L2	D
PSWMO15FP	PBWM015FP	-	-	-	-	SSWM015FP	ASWM015FP	-	1.58	0.37	0.315	0.63	0.58	0.197
PSWMO20FP	PBWM020FP	-	-	-	PSWM020RP	SSWM020FP	ASWM020FP	-	1.97	0.38	0.315	0.79	0.58	0.197
PSWMO24FP	PBWM024FP	-	-	-	-	SSWM024FP	ASWM024FP	-	2.36	0.46	0.394	0.93	0.70	0.236
PSWMO28FP	PBWM028FP	-	-	-	-	SSWM028FP	ASWM028FP	-	2.76	0.51	0.450	1.13	0.85	0.236
PSWMO32FP	PBWM032FP	PSWMO32FP-GF	PBWM032FP-GF	-	PSWM032RP	SSWM032FP	ASWM032FP	-	3.15	0.61	0.510	1.29	0.85	0.315
PSWMO40FP	PBWM040FP	PSWMO40FP-GF	PBWM040FP-GF	-	PSWM040RP	SSWM040FP	ASWM040FP	-	3.94	0.77	0.630	1.63	1.20	0.394
PSWMO48FP	PBWM048FP	PSWMO48FP-GF	PBWM048FP-GF	PSWMO48FSP-GF	-	SSWM048FP	-	-	4.75	0.76	0.625	2.04	1.30	0.394
PSWMO52FP	PBWM052FP	-	-	-	-	SSWM052FP	ASWM052FP	-	5.32	0.90	0.709	2.25	1.50	0.500
PSWMO60FP	PBWM060FP	PSWMO60FP-GF	PBWM060FP-GF	-	PSWM060RP	SSWM060FP	ASWM060FP	PSWMO60FSP	5.91	1.00	0.787	2.54	1.63	0.500
PSWMO70FP	PBWM070FP	PSWMO70FP-GF	PBWM070FP-GF	-	-	-	ASWM070FP	-	7.09	1.00	0.787	3.15	1.92	0.510
PSWMO80FP	PBWM080FP	PSWMO80FP-GF	PBWM080FP-GF	-	PSWM080RP	SSWM080FP	-	-	7.87	1.13	0.906	3.44	2.05	0.625
PSWM100FP	PBWM100FP	PSWM100FP-GF	-	-	-	-	-	-	10.27	1.46	1.102	4.60	2.87	0.750

Note: All dimensions are in decimal inches. For steel hinges, bushing is brass. On stainless steel and aluminum hinges, bushing is stainless steel.

800-3-HINGES • FAX 631-737-2933 • GUDEN.COM



A smooth, unbroken cabinet surface is now possible with Guden concealed hinges. The radius of the movable leaf swings the door out and clear of the cabinet frame. Two standard sizes are ready for welded assembly, or can be custom drilled for screw or bolt assembly. Custom sizes are also available.

CONCEALED HINGES

Part No.	Length	Thickness	Holes	Rib	Leaf Material	Pin Material
NHAL9290	.80	.075	No	No	Aluminum	Stainless
NHAL9291	1.25	.090	No	Yes	Aluminum	Stainless
NHPS9290	.80	.075	No	No	Steel	Steel
NHPS9291	1.25	.090	No	Yes	Steel	Steel
NHSS9290	.80	.075	No	No	Stainless	Stainless
NHSS9291	1.25	.090	No	Yes	Stainless	Stainless

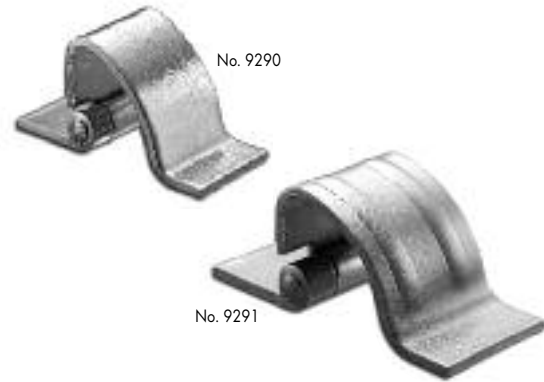

Dual-purpose latch hinges make excellent lid or door latches, or easily removable hinges. The spring-loaded, chamfered pin holds securely, whether used as a latch or a hinge. They are the answer to door removal. "H" prefix parts are supplied with holes.

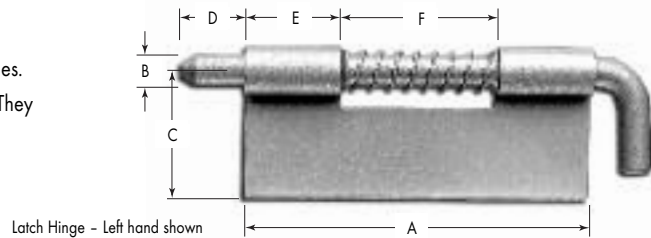

LATCH HINGES

Part No.	Material	Finish	Thickness	Holes	A	B	C	D	E	F
9292LH-02	Steel	Zinc	.040	No	.875	.125	.500	.187	.250	.375
9292RH-02	Steel	Zinc	.040	No	.875	.125	.500	.187	.250	.375
9292LH-32	Stainless	None	.040	No	.875	.125	.500	.187	.250	.375
9292RH-32	Stainless	None	.040	No	.875	.125	.500	.187	.250	.375
9293LH-02	Steel	Zinc	.040	No	1.38	.156	.750	.250	.375	.625
9293RH-02	Steel	Zinc	.040	No	1.38	.156	.750	.250	.375	.625
9293LH-32	Stainless	None	.040	No	1.38	.156	.750	.250	.375	.625
9293RH-32	Stainless	None	.040	No	1.38	.156	.750	.250	.375	.625
9294LH-02	Steel	Zinc	.050	No	2.00	.187	.875	.375	.500	1.00
9294RH-02	Steel	Zinc	.050	No	2.00	.187	.875	.375	.500	1.00
H9294LH-02 *	Steel	Zinc	.050	Yes	2.00	.187	.875	.375	.500	1.00
H9294RH-02 *	Steel	Zinc	.050	Yes	2.00	.187	.875	.375	.500	1.00
9294LH-32	Stainless	None	.050	No	2.00	.187	.875	.375	.500	1.00
9294RH-32	Stainless	None	.050	No	2.00	.187	.875	.375	.500	1.00
H9294LH-32 *	Stainless	None	.050	Yes	2.00	.187	.875	.375	.500	1.00
H9294RH-32 *	Stainless	None	.050	Yes	2.00	.187	.875	.375	.500	1.00
9295LH-02	Steel	Zinc	.062	No	2.75	.250	1.00	.500	.750	1.25
9295RH-02	Steel	Zinc	.062	No	2.75	.250	1.00	.500	.750	1.25
H9295LH-02 *	Steel	Zinc	.062	Yes	2.75	.250	1.00	.500	.750	1.25
H9295RH-02 *	Steel	Zinc	.062	Yes	2.75	.250	1.00	.500	.750	1.25
9295LH-32	Stainless	None	.062	No	2.75	.250	1.00	.500	.750	1.25
9295RH-32	Stainless	None	.062	No	2.75	.250	1.00	.500	.750	1.25
H9295LH-32 *	Stainless	None	.062	Yes	2.75	.250	1.00	.500	.750	1.25
H9295RH-32 *	Stainless	None	.062	Yes	2.75	.250	1.00	.500	.750	1.25

* Supplied from stock with 3 pre-punched .128 diameter holes.

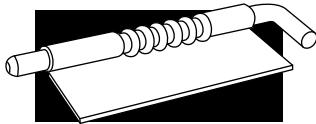

SPECIALTY HINGES



Our heavy-duty latch hinge line is available in standard assembly, and with an optional pin hold back feature (-HB) to lock pin in the retracted position for easier assembly and quick removal of doors.

HEAVY DUTY LATCH HINGES

Part No.	Material	Finish	Thickness	A	B	C	D
9296LH-02	Steel	Zinc	.125	2.00	.375	1.12	1.25
9296LH-02-HB**	Steel	Zinc	.125	2.00	.375	1.12	1.25
9296LH-32	Stainless	None	.125	2.00	.375	1.12	1.25
9296LH-32-HB**	Stainless	None	.125	2.00	.375	1.12	1.25
9296RH-02	Steel	Zinc	.125	2.00	.375	1.12	1.25
9296RH-02-HB**	Steel	Zinc	.125	2.00	.375	1.12	1.25
9296RH-32	Stainless	None	.125	2.00	.375	1.12	1.25
9296RH-32-HB**	Stainless	None	.125	2.00	.375	1.12	1.25
9297LH-02	Steel	Zinc	.187	3.00	.50	1.25	1.50
9297LH-02-HB**	Steel	Zinc	.187	3.00	.50	1.25	1.50
9297LH-32	Stainless	None	.187	3.00	.50	1.25	1.50
9297LH-32-HB**	Stainless	None	.187	3.00	.50	1.25	1.50
9297RH-02	Steel	Zinc	.187	3.00	.50	1.25	1.50
9297RH-02-HB**	Steel	Zinc	.187	3.00	.50	1.25	1.50
9297RH-32	Stainless	None	.187	3.00	.50	1.25	1.50
9297RH-32-HB**	Stainless	None	.187	3.00	.50	1.25	1.50

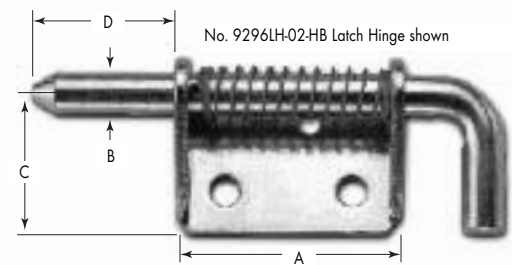

Doors come right off with Guden's un-hinge. It is a quick-release hinge that can be mounted in any position and requires no tools. An easy squeeze of the knurled knobs retracts the spring-loaded pins from the knuckles to release the leaves. Precise manufacturing standards eliminate excess side and end play for minimum door movement.

UN-HINGES - STAINLESS STEEL

Part No.	Thickness	A	B	C	D	E	Holes
9201-32	.050	4.00	.250	1.00	.41	.37	No
H9201-32*	.050	4.00	.250	1.00	.41	.37	Yes
9202-32	.050	4.00	N/A	1.00	N/A	.37	No
H9202-32*	.050	4.00	N/A	1.00	N/A	.37	Yes
9300LH-32	.050	1.75	.250	1.00	.53	.50	No
H9300LH-32*	.050	1.75	.250	1.00	.53	.50	Yes
9300RH-32	.050	1.75	.250	1.00	.53	.50	No
H9300RH-32*	.050	1.75	.250	1.00	.53	.50	Yes

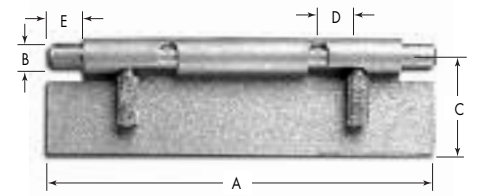

No. 9201-32 Un-Hinge shown

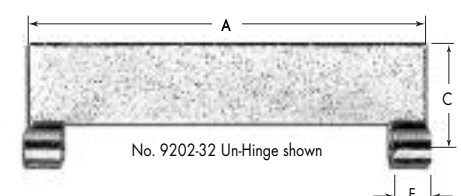

No. 9202-32 Un-Hinge shown

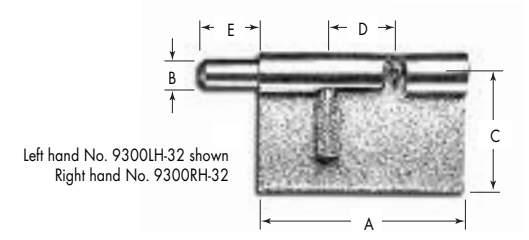

Left hand No. 9300LH-32 shown
Right hand No. 9300RH-32

* Supplied from stock with 3 pre-punched .128 diameter holes.

** Supplied with pin hold back feature.



UN-HINGES - STAINLESS STEEL (cont.)

Part No.	Thickness	A	B	C	D	E	Holes
9401LH-32	.050	1.75	.250	1.00	.41	.37	No
H9401LH-32*	.050	1.75	.250	1.00	.41	.37	Yes
9401RH-32	.050	1.75	.250	1.00	.41	.37	No
H9401RH-32*	.050	1.75	.250	1.00	.41	.37	Yes
9402LH-32	.050	1.75	N/A	1.00	N/A	.37	No
H9402LH-32*	.050	1.75	N/A	1.00	N/A	.37	Yes
9402RH-32	.050	1.75	N/A	1.00	N/A	.37	No
H9402RH-32*	.050	1.75	N/A	1.00	N/A	.37	Yes
9298RV-32	.180	2.89	.50	1.00	1.25	1.33	Yes

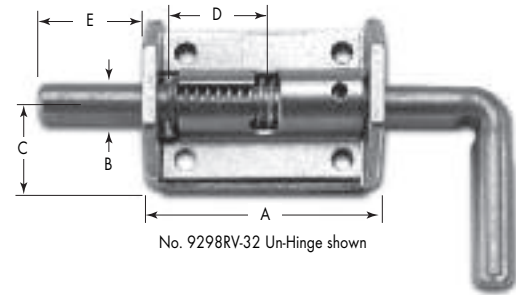

UN-HINGES - STEEL ZINC PLATED

Part No.	Thickness	A	B	C	D	E	Holes
9401LH-02	.050	1.75	.250	1.00	.41	.37	No
H9401LH-02*	.050	1.75	.250	1.00	.41	.37	Yes
9401RH-02	.050	1.75	.250	1.00	.41	.37	No
H9401RH-02*	.050	1.75	.250	1.00	.41	.37	Yes
9402LH-02	.050	1.75	N/A	1.00	N/A	.37	No
H9402LH-02*	.050	1.75	N/A	1.00	N/A	.37	Yes
9402RH-02	.050	1.75	N/A	1.00	N/A	.37	No
H9402RH-02*	.050	1.75	N/A	1.00	N/A	.37	Yes
9403LH-02**	.090	3.50	.365	1.00	1.125	1.50	No
H9403LH-02**	.090	3.50	.365	1.00	1.125	1.50	Yes
9403RH-02**	.090	3.50	.365	1.00	1.125	1.50	No
H9403RH-02**	.090	3.50	.365	1.00	1.125	1.50	Yes
9403BP-02***	.060	3.50	N/A	.75	N/A	N/A	Yes

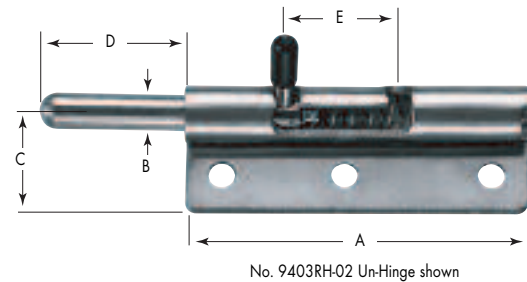
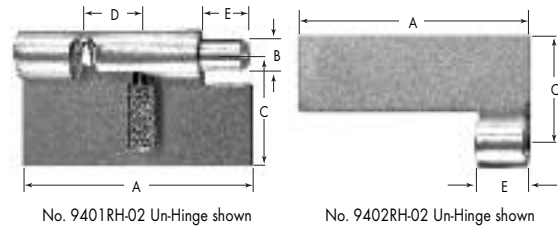

For sizing and mounting information, please see our website at www.guden.com, and look for our invisible hinge calculator in the invisible hinge section. Many other sizes and finishes are available for quick shipment. Contact our customer service department for pricing and availability.

INVISIBLE HINGES

Part No.	Length	Finish
114	1.50	04, 26D
205	2.375	04, 26D
314	1.50	04, 26D



* Supplied from stock with 2 pre-punched .128 diameter holes.

** Supplied with black vinyl pin handle cap.

*** Mounting backplate

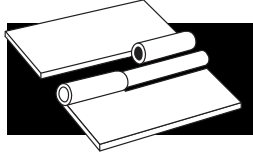

SPECIALTY HINGES

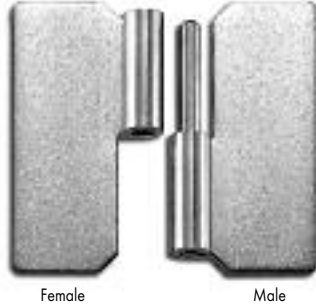

No. 801
Right hand shown

Female

Male

Quick, easy and economical door removals are the benefits of Guden slip joint hinges. Custom sizes, constructions and hole patterns are also available.

SLIP JOINT HINGES – NO HOLES

Leaf Thick. .050 Pin Dia. .120

Open Width*	SS Leaf & Pin	Steel Leaf & Pin	Alum w/SS Pin	Length
1.44	NHSS801LF	NHPS801LF	NHAL801LF	1.50
	NHSS801LM	NHPS801LM	NHAL801LM	
	NHSS801RF	NHPS801RF	NHAL801RF	
	NHSS801RM	NHPS801RM	NHAL801RM	

Leaf Thick. .080 Pin Dia. .187

Open Width*	SS Leaf & Pin	Alum w/SS Pin	Length
1.68	NHSS80220LF	NHAL80220LF	2.00
	NHSS80220LM	NHAL80220LM	
	NHSS80220RF	NHAL80220RF	
	NHSS80220RM	NHAL80220RM	

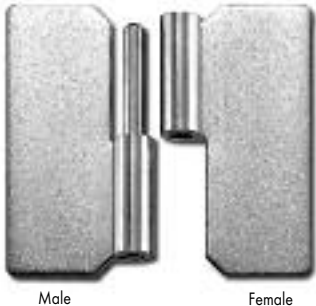

Male

Female

Leaf Thick. .072 Pin Dia. .125

Open Width*	Steel Leaf & Pin	Length
1.68	NHPS80220LF	2.00
	NHPS80220LM	
	NHPS80220RF	
	NHPS80220RM	

Leaf Thick. .075 Pin Dia. .187

Open Width*	Steel Leaf & Pin	Length
1.87	NHPS80225LF	2.50
	NHPS80225LM	
	NHPS80225RF	
	NHPS80225RM	



Female

Male

Series No. 802 &
No. 806
Right hand shown

Leaf Thick. .080 Pin Dia. .187

Open Width*	Steel Leaf & Pin	Length
2.00	NHPS80620LF	2.00
	NHPS80620LM	
	NHPS80620RF	
	NHPS80620RM	

Leaf Thick. .093 Pin Dia. .187

Open Width*	Steel Leaf & Pin	Length
2.50	NHPS80625LF	2.50
	NHPS80625LM	
	NHPS80625RF	
	NHPS80625RM	



Male

Female

Series No. 802 &
No. 806
Left hand shown

Leaf Thick. .093 Pin Dia. .250

Open Width*	SS Leaf & Pin	Steel Leaf & Pin	Length
3.00	NHSS80630LF	NHPS80630LF	3.00
	NHSS80630LM	NHPS80630LM	
	NHSS80630RF	NHPS80630RF	
	NHSS80630RM	NHPS80630RM	

Leaf Thick. .093 Pin Dia. .187

Open Width*	SS Leaf & Pin	Length
2.00	NHSS80230LF	3.00
	NHSS80230LM	
	NHSS80230RF	
	NHSS80230RM	

Leaf Thick. .075 Pin Dia. .187

Open Width*	SS Leaf & Pin	Length
2.50	NHSS80625LF	2.50
	NHSS80625LM	
	NHSS80625RF	
	NHSS80625RM	

* Open width when assembled.



SLIP JOINT HINGES – WITH HOLES

Leaf Thick. .050 Pin Dia. .120

Open Width*	SS Leaf & Pin	Steel Leaf & Pin	Alum w/SS Pin	Length
1.44	WHSS801LF	WHNP801LF**	WHAL801LF	1.50
	WHSS801LM	WHNP801LM**	WHAL801LM	
	WHSS801RF	WHNP801RF**	WHAL801RF	
	WHSS801RM	WHNP801RM**	WHAL801RM	

No. 801
Right hand shown

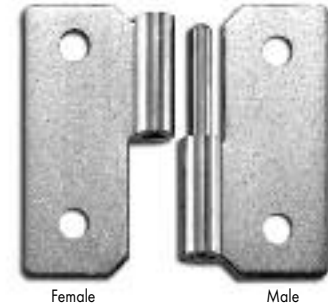

Leaf Thick. .080 Pin Dia. .187

Open Width*	SS Leaf & Pin	Alum w/SS Pin	Length
1.68	WHSS80220LF	WHAL80220LF	2.00
	WHSS80220LM	WHAL80220LM	
	WHSS80220RF	WHAL80220RF	
	WHSS80220RM	WHAL80220RM	

Female Male

Leaf Thick. .072 Pin Dia. .125

Open Width*	Steel Leaf & Pin	Length
1.68	WHPS80220LF	2.00
	WHPS80220LM	
	WHPS80220RF	
	WHPS80220RM	

Leaf Thick. .075 Pin Dia. .187

Open Width*	Steel Leaf & Pin	Length
1.87	WHPS80225LF	2.50
	WHPS80225LM	
	WHPS80225RF	
	WHPS80225RM	



Male Female

Leaf Thick. .080 Pin Dia. .187

Open Width*	Steel Leaf & Pin	Length
2.00	WHPS80620LF	2.00
	WHPS80620LM	
	WHPS80620RF	
	WHPS80620RM	

Leaf Thick. .093 Pin Dia. .187

Open Width*	Steel Leaf & Pin	Length
2.50	WHPS80625LF	2.50
	WHPS80625LM	
	WHPS80625RF	
	WHPS80625RM	

Series No. 802 &
No. 806
Right hand shown



Female Male

Leaf Thick. .093 Pin Dia. .250

Open Width*	SS Leaf & Pin	Steel Leaf & Pin	Length
3.00	WHSS80630LF	WHPS80630LF	3.00
	WHSS80630LM	WHPS80630LM	
	WHSS80630RF	WHPS80630RF	
	WHSS80630RM	WHPS80630RM	

Leaf Thick. .093 Pin Dia. .187

Open Width*	SS Leaf & Pin	Length
2.00	WHSS80230LF	3.00
	WHSS80230LM	
	WHSS80230RF	
	WHSS80230RM	

Leaf Thick. .075 Pin Dia. .187

Open Width*	SS Leaf & Pin	Length
2.50	WHSS80625LF	2.50
	WHSS80625LM	
	WHSS80625RF	
	WHSS80625RM	

Series No. 802 &
No. 806
Left hand shown



Male Female

Leaf Thick. .093 Pin Dia. .250

Open Width*	SS Leaf & Pin	Length
3.00	9299LH-32***	3.00

Please go to www.guden.com for individual drawings with sizes and hole placements.

* Open width when assembled.
** Nickel-plated Pin.
*** Motor box hinge, stainless electropolished with 3 ctsk holes each leaf.

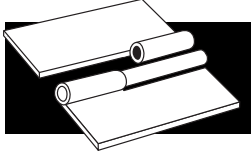

SPECIALTY HINGES

Hold doors open or closed with Gudén spring hinges. Butts are carried in stock for either surface or concealed mounting in several sizes, materials and finishes. Custom continuous and butt spring hinges are made to your individual specifications. **For more detailed information about dimensions and torques, see our accompanying Spring Hinge Design Form.**

SPRING HINGES - NO HOLES

Part No.	Open Length	Width	Thickness	Pin	Material	Finish	Normal Loading
NHPS1114	1.25	.75	.025	.062	Steel	None	Open
NHSTS1114	1.25	.75	.025	.062	Stainless	None	Open
NHPS1115	1.25	.75	.025	.062	Steel	None	Closed
NHSTS1115	1.25	.75	.025	.062	Stainless	None	Closed
NHPS1116	1.75	1.50	.035	.086	Steel	None	Open
NHSTS1116	1.75	1.50	.035	.086	Stainless	None	Open
NHPS1117	2.18	1.25	.050	.115	Steel	None	Open
NHSTS1117	2.18	1.25	.050	.115	Stainless	None	Open
NHPS1120	3.50	1.50	.040	.091	Steel	None	Open
NHSTS1120	3.50	1.50	.040	.091	Stainless	None	Open
NHPS1121	3.50	1.50	.040	.091	Steel	None	Close
NHSTS1121	3.50	1.50	.040	.091	Stainless	None	Close
NHPS1122	5.00	2.00	.050	.120	Steel	None	Open
NHSTS1122	5.00	2.00	.050	.120	Stainless	None	Open
NHPS1123	5.00	2.00	.050	.120	Steel	None	Close
NHSTS1123	5.00	2.00	.050	.120	Stainless	None	Close

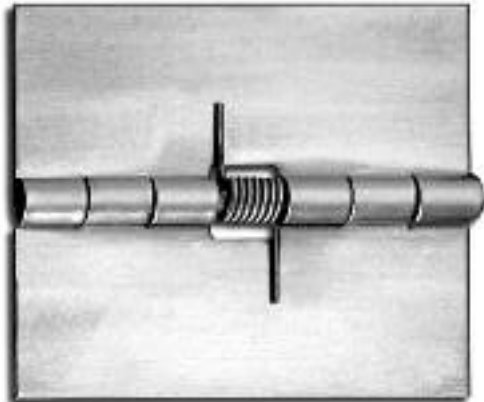

Spring loaded to open shown; for spring loaded to close versions, spring legs are on the opposite sides of the leaves

SPRING HINGES—WITH HOLES

Part No.	Open Length	Width	Thickness	Pin	Material	Finish	Normal Loading
1114-02	1.25	.75	.025	.062	Steel	Zinc	Open
STS1114	1.25	.75	.025	.062	Stainless	None	Open
1116-02	1.75	1.50	.035	.086	Steel	Zinc	Open
STS1116	1.75	1.50	.035	.082	Stainless	None	Open
1117-02	2.18	1.25	.050	.115	Steel	Zinc	Open
STS1117	2.18	1.25	.050	.115	Stainless	None	Open
1643-02	2.00	1.00	.040	.091	Steel †	Zinc	Open
1644-02	2.00	1.00	.040	.091	Steel †	Zinc	Closed
STS1644035	2.00	1.00	.035	.091	Stainless**	None	Closed
STS1643025	2.00	1.00	.035	.091	Stainless*	None	Open
STS1643035	2.00	1.00	.035	.091	Stainless**	None	Open
PS1120-02	3.50	1.50	.040	.091	Steel	Zinc	Open
STS1120	3.50	1.50	.040	.091	Stainless	None	Open
PS1121-02	3.50	1.50	.040	.091	Steel	Zinc	Close
STS1121	3.50	1.50	.040	.091	Stainless	None	Close
PS1122-02	5.00	2.00	.050	.120	Steel	Zinc	Open
STS1122	5.00	2.00	.050	.120	Stainless	None	Open
PS1123-02	5.00	2.00	.050	.120	Steel	Zinc	Close
STS1123	5.00	2.00	.050	.120	Stainless	None	Close

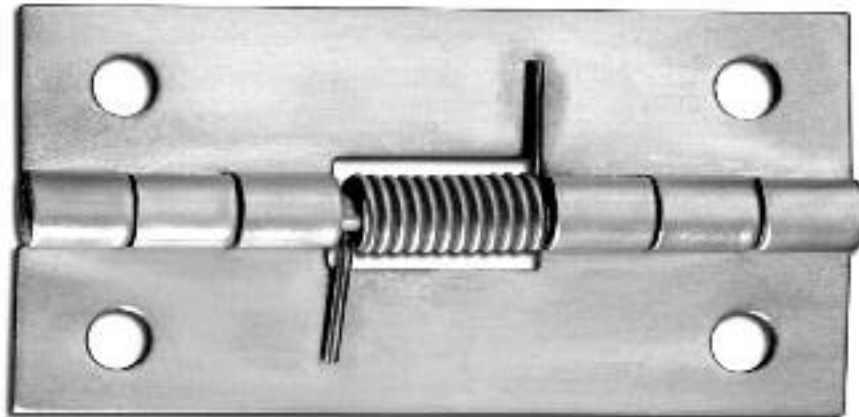

* .025 spring wire diameter.
** .035 spring wire diameter.

† Supplied with brass pin.

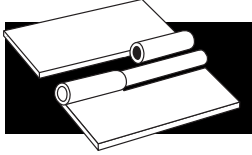

SPECIALTY HINGES

Our new spring hinges provide higher spring tensions using both thicker and multiple springs. The .060" thick leaves are heavier, and offered in steel or stainless, with or without holes. All the hinges are assembled with a .050" or .055" wire spring for more strength; the 5.375" and 8.75" versions are assembled with two springs to handle heavy-duty applications. Prototypes are available to qualified customers.



SPRING HINGES - WITH HOLES

Part No.	Open Length	Width	Thickness	Pin	Material	Finish	Normal Loading
WHPS1124	3.25	1.50	.060	.055	Steel	None	Open
WHPS1125	3.25	1.50	.060	.055	Steel	None	Closed
WHSTS1124	3.25	1.50	.060	.055	Stainless	None	Open
WHSTS1125	3.25	1.50	.060	.055	Stainless	None	Closed



SPRING HINGES - NO HOLES

Part No.	Open Length	Width	Thickness	Pin	Material	Finish	Normal Loading
NHPS1124	3.25	1.50	.060	.055	Steel	None	Open
NHPS1125	3.25	1.50	.060	.055	Steel	None	Closed
NHSTS1124	3.25	1.50	.060	.055	Stainless	None	Open
NHSTS1125	3.25	1.50	.060	.055	Stainless	None	Closed



SPRING HINGES - NO HOLES

Part No.	Open Length	Width	Thickness	Pin	Material	Finish	Normal Loading
NHPS1126	5.375	1.50	.060	.055	Steel	None	Open
NHPS1127	5.375	1.50	.060	.055	Steel	None	Closed
NHSTS1126	5.375	1.50	.060	.055	Stainless	None	Open
NHSTS1127	5.375	1.50	.060	.055	Stainless	None	Closed



SPRING HINGES - WITH HOLES

Part No.	Open Length	Width	Thickness	Pin	Material	Finish	Normal Loading
WHPS1126	5.375	1.50	.050	.055	Steel	None	Open
WHPS1127	5.375	1.50	.050	.055	Steel	None	Closed
WHSTS1126	5.375	1.50	.050	.055	Stainless	None	Open
WHSTS1127	5.375	1.50	.050	.055	Stainless	None	Closed



SPRING HINGES - NO HOLES

Part No.	Open Length	Width	Thickness	Pin	Material	Finish	Normal Loading
NHPS1128	8.75	1.50	.050	.090	Steel	None	Open
NHPS1129	8.75	1.50	.050	.090	Steel	None	Closed
NHSTS1128	8.75	1.50	.050	.090	Stainless	None	Open
NHSTS1129	8.75	1.50	.050	.090	Stainless	None	Closed

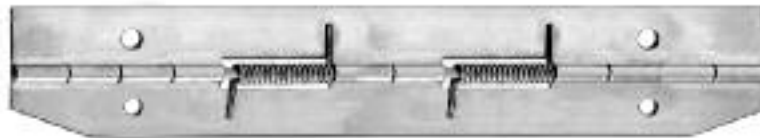

SPRING HINGES - WITH HOLES

Part No.	Open Length	Width	Thickness	Pin	Material	Finish	Normal Loading
WHPS1128	8.75	1.50	.050	.090	Steel	None	Open
WHPS1129	8.75	1.50	.050	.090	Steel	None	Closed
WHSTS1128	8.75	1.50	.050	.090	Stainless	None	Open
WHSTS1129	8.75	1.50	.050	.090	Stainless	None	Closed

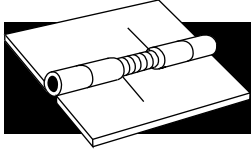

SPECIALTY HINGES

PLAIN STEEL FLAG HINGES

Part No.	Assembled Length	Leaf Width	Leaf Thickness	Pin Diameter
NHPS836*	2.00	.68	.050	.130
NHPS1474LF	2.37	1.20	.060	.156
NHPS1474LM	2.37	1.20	.060	.156
NHPS1474RF	2.37	1.20	.060	.156
NHPS1474RM	2.37	1.20	.060	.156

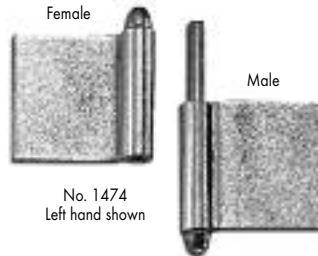

STAINLESS STEEL FLAG HINGES

Part No.	Assembled Length	Leaf Width	Leaf Thickness	Pin Diameter
NHSS1485F**	2.00	1.00	.050	.120
NHSS1485LM	2.00	1.00	.050	.120
NHSS1485RM	2.00	1.00	.050	.120



STAINLESS STRAP / T- HINGES

Item	Length	Material	Description
STRP0315RVA1	3.15	Polished Stainless	Flat, reversible w/ round holes
STRP0472RVA1	4.72	Polished Stainless	Flat, reversible w/ round holes
STRP0472RVB1	4.72	Polished Stainless	Reversible, high profile style w/ctsk holes

BIFOLD SCREEN DOOR HINGES—BRASS PLATED

Item	Length	Thickness	Panel Thickness
BIFOLD551-075	1.75	.048	.75 - 1.00
BIFOLD551-100	2.00	.058	1.00 - 1.125
BIFOLD551-125	2.00	.058	1.125 - 1.25



COVER HINGES

Part No.	Length	Width	Thickness	Pin	Material	Finish	Holes
1645-02	1.562	2.00	.050	.115	Steel	Zinc	2



CABINET SPRING HINGES

Part No.	Open Width	Open Length	Thickness	Pin	Material	Normal Finish	Normal Loading	Holes
343-1-14	1.61	1.11	.050	.120	Steel	Nickel	Open	4
343-1-03	1.61	1.11	.050	.120	Steel	Brass	Open	4

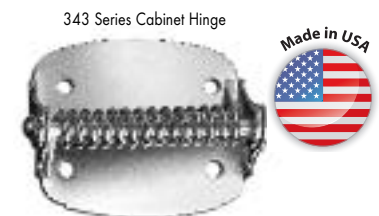

* Sold as a male/female set.

** Female is reversible for LM or RM.

HINGESHANDLESSTRIKESLATCHESSTRAPSHOOKSHINGESH LATCHESSTRAPS



MILITARY HARDWARE

CONTENTS

30	<i>MS-20001 Series Hinges</i>	31	<i>MS-35000 Series Hinges</i>	32	<i>Chest Handles</i>
30	<i>MS-20257 Series Hinges</i>	31	<i>A-A-55000 Series Hinges</i>	32	<i>Spring-Loaded Chest Handles</i>
30	<i>MS-20253 Series Hinges</i>	31	<i>Compression Spring Catches</i>	32	<i>Navy Locker Hardware</i>

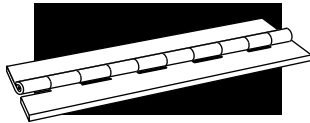

MILITARY HARDWARE



MS20001 SERIES CONTINUOUS HINGES; TYPE 2024-T3511 EXTRUDED ALUMINUM

Specify	For
P	Anodized per Mil-A-8625, Type II
C	Alodine per Mil-DTL-5541
A	Aluminum Alloy 7075-T 73511

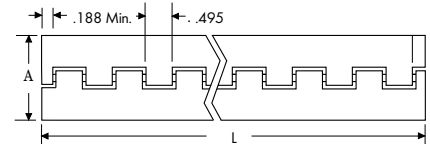
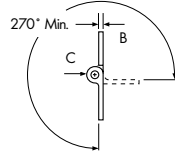

Dash No.	A Open Width	B - Leaf Thickness		C Pin Diameter
		Maximum	Minimum	
-2	1.062	.056	.044	.090
-3	1.250	.056	.044	.090
-4	1.500	.056	.044	.090
-5	1.750	.056	.044	.090
-6	2.000	.056	.044	.090
-8	2.000	.076	.064	.180
-9	2.500	.056	.044	.090
-10	2.750	.056	.044	.090
-12	3.375	.115	.103	.090
-14	3.719	.163	.149	.129
-16	3.938	.210	.196	.180

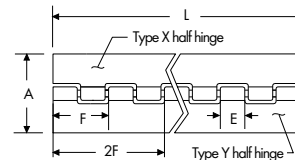
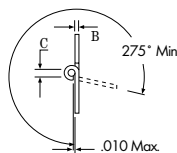
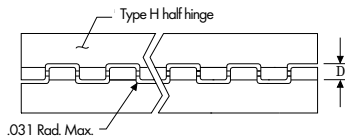

MS20257 SERIES CONTINUOUS HINGES

Dash No.			A	B Leaf Thickness		C Hole Diameter		D Slot Depth		E	F	Pin Diameter
Alum. Alloy	Unano- dized	Ano- dized	Open Width	Alum. Alloy	Cor. Res. Steel	Alum. Alloy	Cor. Res. Steel	Alum. Alloy	Cor. Res. Steel	Loop	Pitch	Cor. Res. Steel
1	P1	C1	.75	.032	.031	.066	.066	.169	.166	.490	1.000	.063
2	P2	C2	1.06	.040	.037	.093	.093	.220	.211	.490	1.000	.090
3	P3	C3	1.25	.040	.050	.093	.121	.220	.278	.490	1.000	.118
4	P4	C4	1.50	.040	.062	.093	.121	.220	.314	.490	1.000	.118
5	P5	C5	2.00	.051	.062	.093	.183	.253	.376	.490	1.000	.180
6	P6	C6	2.00	.064	.062	.183	.183	.382	.376	1.990	4.047	.180

MS20253* AND A-A-55486 HINGE PINS FOR MS20257 AND MS20001 SERIES CONTINUOUS HINGES

Dash No.	Cadmium plated		Passivated	Diameter
	P1	P2		
-P1	-1			.062
-P2	-2			.089
-P3	-3			.117
-P4	-4			.179
-P5	-5			.129

1. Use cadmium-plated, corrosion-resistant steel with aluminum alloy hinge.
2. Use passivated corrosion-resistant steel pin with corrosion-resistant steel hinge.
3. Normally supplied 72" long, i.e., MS20253-7200.
4. Add L length to denote solid film lubricant.

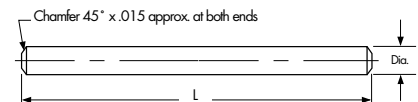



MS-35000 SERIES CONTINUOUS HINGES

MS No.	Leaf				Dash No. - Open Width																			
	Thickness	Knuckle	Pin Dia.	Length	-1	-2	-3	-4	-5	-6	-7	-8	-9	-10	-11	-12	-13	-14	-15	-16	-17	-18	-19	-20
MS-35821	.032	.50	.063	72						.75	1	1.06	1.25	1.5										
MS-35822	.040	.50	.091	72									1.06	1.25	1.5	2								
	.040	.62	.091	72.50													1.06	1.25	1.5	2				
MS-35823	.050	.62	.125	72.50					1.06	1.5	2	2.5												
MS-35825	.060	.62	.125	85									1.06	1.5	2	2.5								
	.060	1	.125	84													1.06	1.5	2	2.5				
MS-35826	.060	1	.187	84									1.06	1.5	2	2.5								
	.060	2	.187	84													1.06	1.5	2	2.5				
MS-35829	.075	2	.187	84											2	2.5	3	3.5	4					
	.075	2	.250	84															2	2.5	3	3.5	4	
MS-35830	.090	2	.250	84										3	3.5	4	5							
	.090	2	.312					4	5	6														
	.090	2	.375	84															4	5	6			
MS-35831	.125	2	.312		4	5																		
	.125	2	.375	84						4	5	6												

- Notes: 1. The MS part number consists of the MS No. plus the Dash No. followed by the applicable letter for material, i.e., MS35821-6A or MS35821-8D.
 2. Materials are available in A aluminum, B brass leaf & copper pin, C stainless steel leaf & pin, D plain steel leaf & pin, and E plain steel leaf, cadmium-plated & brass pin.
 3. When protective finish is required for D materials, add F to the dash number, i.e., MS35821-8DF.
 4. See Military Specifications for more detailed information on materials and finishes.

A-A-55000 SERIES CONTINUOUS HINGES

MS No.	Leaf				Dash No. - Open Width																			
	Thickness	Knuckle	Pin Dia.	Length	-1	-2	-3	-4	-5	-6	-7	-8	-9	-10	-11	-12	-13	-14	-15	-16	-17	-18	-19	-20
A-A-55589	.032	.50	.063	72						.75	1	1.06	1.25	1.5										
A-A-55590	.040	.50	.091	72									1.06	1.25	1.5	2								
	.040	.62	.091	72.50													1.06	1.25	1.5	2				
A-A-55591	.050	.62	.125	72.50					1.06	1.5	2	2.5												
A-A-55592	.060	.62	.125	85									1.06	1.5	2	2.5								
	.060	1	.125	84													1.06	1.5	2	2.5				
A-A-55593	.060	1	.187	84									1.06	1.5	2	2.5								
	.060	2	.187	84													1.06	1.5	2	2.5				
A-A-55594	.075	2	.187	84											2	2.5	3	3.5	4					
	.075	2	.250	84															2	2.5	3	3.5	4	
A-A-55595	.090	2	.250	84										3	3.5	4	5							
	.090	2	.312					4	5	6														
	.090	2	.375	84															4	5	6			
A-A-55596	.125	2	.312		4	5																		
	.125	2	.375	84						4	5	6												

- Notes: 1. The AA part number consists of the AA No. plus the Dash No. followed by the applicable letter for material, i.e., AA55589-6A or AA55589-8D.
 2. Materials are available in A aluminum, B brass leaf & copper pin, C stainless steel leaf & pin, D plain steel leaf & pin, and E plain steel leaf, cadmium-plated & brass pin.
 3. C materials will be supplied with passivated leaves.
 4. When protective finish is required for D materials, add F to the dash number, i.e., AA55589-8DF.
 5. See Military Specifications for more detailed information on materials and finishes.

COMPRESSION SPRING CATCH AND STRIKE

Part No.	Overall Length	Maximum Width	Holes	Material	Finish
MS18015002 (Catch)	Per MS	Per MS	.128	Steel & Stainless	Zinc with Yellow Chromate
MS18015003 (Strike)	Per MS	Per MS	.128	Steel & Stainless	Zinc with Yellow Chromate

Note: One (1) MS-18015-2 (Catch) and one (1) MS-18015-3 (Strike) equals one (1) MS-18015-1.



MILITARY HARDWARE



CHEST HANDLES

Part No.	Finish	Holes	Plate	Width of Bail Inside	Material
MS35791001	Per MS	4	3.62 x 2.94	3.50	Steel
MS35791002	Per MS	4	4.88 x 4.19	4.50	Steel
MS35793001	Per MS	5	4.88 x 4.19	4.50	Steel

SPRING-LOADED CHEST HANDLES

Part No.	Finish	Holes	Plate	Width of Bail Inside	Material Back Plate	Bail
MS18012001	Per MS	Yes	4.75 x 2.75	4.38	Per MS	Per MS
MS18012002	Per MS	No	4.75 x 2.75	4.38	Per MS	Per MS
MS18012003	Per MS	Yes	4.75 x 2.75	4.38	Per MS	Per MS
MS18012004	Per MS	No	4.75 x 2.75	4.38	Per MS	Per MS
MS18012005	Per MS	Yes	4.75 x 2.75	4.38	Per MS	Per MS
MS18012006	Per MS	No	4.75 x 2.75	4.38	Per MS	Per MS

NAVY LOCKER HARDWARE



No. 8696-15
Buships-Part No. 13
2" "T" Handle
Cast Brass
Satin Nickel



No. 8726-32
Buships-Part No. 42
Latch
Escutcheon
Stainless Steel



No. 7174-15
Buships-Part No. 5
3" Pull
Cast Brass
Satin Nickel



No. 8697-15
Buships-Part No. 21
2" "T" Handle
Cast Brass
Satin Nickel



No. 8213-02
Buships-Part No. 41
Latch
Plain Steel
Zinc Plated



No. 8613-15
Buships-Part No. 32
Handle
Cast Brass
Satin Nickel

No. 8213-32
Stainless Steel



No. 8234-15
Buships-Part No. 33
Cast Brass Strike
Satin Nickel



No. 8612-02
Buships-Part No. 40
Strap
Steel
Zinc-Plated

No. 8612-32
Stainless Steel



No. 10406-15*
Buships-Part No. 10
Strike
Cast Brass
Satin Nickel



No. 8614-02
Buships-Part No. 39
Cam
Steel
Zinc-Plated

No. 8614-32
Stainless Steel

Note: Reference Buships Print No. S-3200-860055.

RODPULLSDIECASTPULLSSTEELHANDLES DOORPULLSCHESTHANDLESSPRING



HANDLES & PULLS

CONTENTS

34 Rod Pulls

34 Diecast Pulls

34 Stainless Steel Pulls

35 Aluminum Pulls

35 Brass Pulls

36 Steel Handles

36 Solid Brass Knobs

36 Flush Door Pulls

37 Flush Drawer Pulls

37 Chest Handles

38 Steel Cover Chest Handles

38 Spring-Loaded Chest Handles



HANDLES AND PULLS



ROD PULLS

Part No.	C to C	Projection	Rod Dia.	Material	Finish	Tapped
750-26D	2.50	1.22	.312	Brass	Satin Chrome	8-32
751-26D	3.00	1.22	.312	Brass	Satin Chrome	8-32
752-26D	3.50	1.22	.312	Brass	Satin Chrome	8-32
753-26D	4.00	1.22	.312	Brass	Satin Chrome	8-32
754-26D	5.00	1.22	.312	Brass	Satin Chrome	8-32
851-32B	3.00	1.40	.375	Stainless	Burnished	8-32
852-32B	3.50	1.40	.375	Stainless	Burnished	8-32
853-32B	4.00	1.40	.375	Stainless	Burnished	8-32
854-32B	5.00	1.40	.375	Stainless	Burnished	8-32
951-28A	3.00	1.22	.312	Aluminum	Satin Anodized	8-32
952-28A	3.50	1.22	.312	Aluminum	Satin Anodized	8-32
953-28A	4.00	1.22	.312	Aluminum	Satin Anodized	8-32
954-28A	5.00	1.22	.312	Aluminum	Satin Anodized	8-32



DIE CAST PULLS

Part No.	C to C	Projection	Face	Finish	Tapped
R102-26	3.00	.81	.31	Bright Chrome	8-32



Part No.	C to C	Projection	Face	Finish	Tapped
4750-26	2.75	.70	.27	Bright Chrome	8-32



Part No.	C to C	Projection	Face	Finish	Tapped
2197-26	4.00	1.00	-	Polished Chrome	10-24



STAINLESS STEEL PULLS

Part No.	C to C	Projection	Face	Finish	Tapped
1900-32D	4.00	1.31	.625	Satin	8-32
1901-32D	5.00	1.31	.625	Satin	8-32

ALUMINUM PULLS

Part No.	C to C	Projection	Overall	Finish	Tapped
420-28A	1.00	.87	2.00	Satin Anodized	8-32
425-28A	1.50	.87	2.50	Satin Anodized	8-32
435-28A*	2.50	.87	3.50	Satin Anodized	8-32
445-28A	3.50	.87	4.50	Satin Anodized	8-32
455-28A	3.50	.87	5.50	Satin Anodized	8-32



Part No.	C to C	Projection	Face	Finish	Tapped
165-28A	3.50	.87	.500	Satin Anodized	8-32
167-28A	3.00	.87	.500	Satin Anodized	8-32
2041-28A	4.00	1.06	.313	Satin Anodized	10-24



Part No.	C to C	Projection	Face	Finish	Tapped
7929-28A	3.75	1.00	.375	Satin Anodized	10-24
8215-28A	4.00	1.06	.437	Satin Anodized	10-24
8419-28A	5.00	.94	.375	Satin Anodized	10-24



Part No.	C to C	Projection	Face	Finish	Tapped
5207-28A	3.75	1.01	.625	Satin Anodized	10-24
2644-28A	4.00	1.01	.625	Satin Anodized	10-24
7005-28A	4.00	1.01	.500	Satin Anodized	10-24



* Tapped with 4 holes for both 2.50" or 3.00" C to C

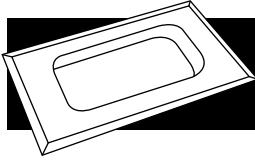

HANDLES AND PULLS



No. 482



No. 14786-26



No. 1904-26



No. 8305-14

STEEL HANDLES

Part No.	Finish	Holes	Size
482-1-02	Zinc	Yes	5.00 x 1.25
482-2-02	Zinc	Yes	5.75 x 1.50
NHPS48220	None	No	5.75 x 1.50
482-3-02	Zinc	Yes	6.53 x 1.62
NHPS48230	None	No	6.37 x 1.62
482-4-02	Zinc	Yes	7.75 x 2.25

Part No.	Overall Length	Projection	Hole Diameter	Finish
14786-26	13.00	2.20	1/4-20 ctsk	Bright Chrome
1904-26	8.31	1.75	#14 ctsk	Bright Chrome
8305-14	4.68	1.40	.213	Bright Nickel



Series G101, G102, G103 & G105 knobs

SOLID BRASS KNOBS

Part No.	Finishes	Diameter	Tapped
G102-26	Bright Chrome	.62	10-24
G103-03	Bright Brass	.87	10-24
G103-26	Bright Chrome	.87	10-24

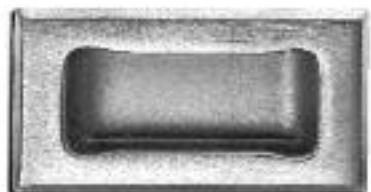

FLUSH DOOR PULLS

Part No.	Material	Mounting	C to C	Finish	Plate Size
1896-32D	Stainless	Flat for Spot Welding	-	Satin	4.75 x 2.42
1897-32D	Stainless	Beveled Edge w/ 10-32 Studs	4.00	Satin	4.75 x 2.42

FLUSH DRAWER PULLS

Part No.	Material	Mounting	C to C	Finish	Plate Size
1898-02	Steel	Flat for Spot Welding	-	Zinc	4.75 x 2.42
1898-32D	Stainless	Flat for Spot Welding	-	Satin	4.75 x 2.42
1899-02	Steel	Beveled Edge w/ 10-32 Studs	4.00	Zinc	4.75 x 2.42
1899-32D	Stainless	Beveled Edge w/ 10-32 Studs	4.00	Satin	4.75 x 2.42
7338-32D	Stainless	Flat for Spot Welding	-	Satin	4.00 x 2.00
7836-32D	Stainless	Beveled Edge w/ 8-32 Studs	3.62	Satin	4.00 x 2.00

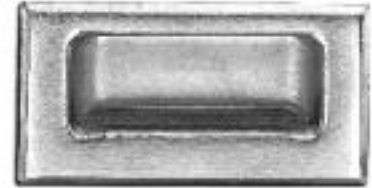

No. 1899-02, 1899-32, 7836-32D,
and 7836-26D

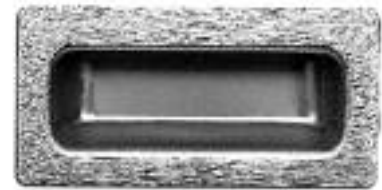

No. 1898-02, 1898-32D
and 7338-32D

CHEST HANDLES

Part No.	Finish	Holes	Plate	Width of Bail		Material
				Inside	Outside	
1205-275-02*	Zinc	3	2.68 x 2.00	2.75	2.75	Steel
1205-350-02	Zinc	4	3.62 x 2.94	3.62	3.62	Steel
NHPS1205-350	None	None	3.62 x 2.94	3.62	3.62	Steel
1205-400-02	Zinc	4	4.06 x 3.00	4.12	4.12	Steel
NHPS1205-400	None	None	4.06 x 3.00	4.12	4.12	Steel
1205-475-02	Zinc	4	4.88 x 4.19	4.50	4.50	Steel
NHSS1207	None	None	3.38 x 1.75	3.37	3.37	Stainless
WHSS1207	None	4	3.38 x 1.75	3.32	3.32	Stainless
NHPS1207	None	None	3.38 x 1.75	3.37	3.37	Steel



No. 1205



No. 1207

* 3rd hole centered on top half of plate.



HANDLES AND PULLS



No. 8310

STEEL COVER CHEST HANDLES

Part No.	Finish	Holes	Width of Bail	
			Plate	Inside
8310-14	Nickel	.201	3.62 x 1.78	3.75
NHPS8310	None	No	3.62 x 1.78	3.75



No. 8315

SPRING-LOADED CHEST HANDLES

Part No.	Finish	Holes	Plate	Width of Bail		Material	
				Inside	Back Plate	Bail	
NHPS8315	None	No	5.12 x 1.62	4.50	Steel	Steel	
8315-14	Nickel	Yes	5.12 x 1.62	4.50	Steel	Steel	



No. 945



No. 955

SPRING-LOADED CHEST HANDLES

Part No.	Finish	Holes	Plate	Width of Bail		Material	
				Inside	Back Plate	Bail	
945SS2RG	None	No	4.91 x 2.88	4.50	Aluminum	Stainless	
H955AL2RG	None	Yes	4.88 x 2.00	4.06	Aluminum	Aluminum	



No. 1209

SPRING-LOADED CHEST HANDLES

Part No.	Finish	Holes	Plate	Width of Bail		Material
				Inside		
1209-14	Nickel	#10	5.00 x 2.44	3.75	Steel	

COMPRESSION SPRING CATCHES DRAW PULL CATCHES LID SUPPORTS FALL SUPPORTS LEG LEVEL

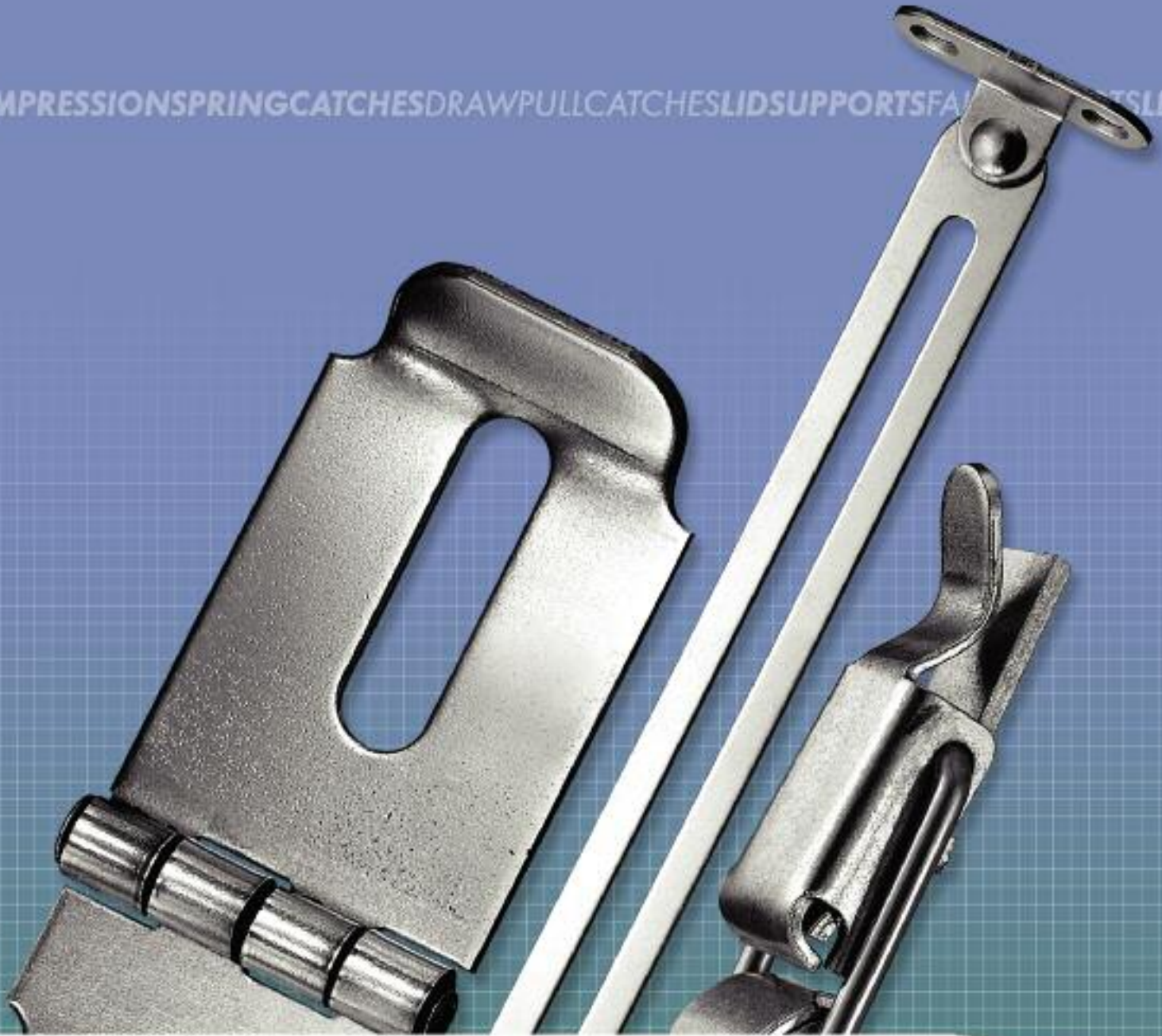

CATCHES & SUPPORTS

CONTENTS

40	Compression Spring Catches	41	Slam Latches	42	Lid Supports
40	Draw Pull Catches	41	Snap-in Magnetic Catches	42	Table Leg Supports
40	Nonmagnetic Catches	42	Reversible Lid Supports		
41	Hasps & Staples	42	Fall Supports		

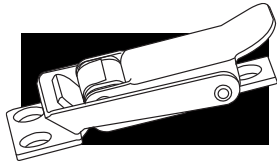

CATCHES, HASPS & STAPLES



No. 8341



No. 8342



No. 8330 & 8331



No. 8332



No. 8333



No. 8335



COMPRESSION SPRING CATCHES

Part No.	Overall Length	Max. Width	Holes	Material	Finish
NHPS8341	2.75	1.14	None	Steel	None
8341-02	2.75	1.14	.144	Steel	Zinc
NHSTS8341	2.75	1.14	None	Stainless	None
8341-32	2.75	1.14	.144	Stainless	None
NHPS8342	3.34	1.82	None	Steel	None
8342-02	3.34	1.82	.130	Steel	Zinc
NHSTS8342	3.34	1.82	None	Stainless	None
8342-32	3.34	1.82	.216	Stainless	None

DRAW PULL CATCHES

Part No.	Overall Length	Max. Width	Holes	Material	Finish
NHPS8330	2.09	1.06	None	Steel	None
8330-02	2.09	1.06	.130	Steel	Zinc
NHSTS8330	2.09	1.06	None	Stainless	None
8330-32	2.09	1.06	.130	Stainless	None
NHPS8331	2.43	1.03	None	Steel	None
8331-02	2.43	1.03	.130	Steel	Zinc
NHSTS8331	2.43	1.03	None	Stainless	None
8331-32	2.43	1.03	.130	Stainless	None
NHPS8332	2.25	.93	None	Steel	None
8332-02	2.25	.93	.130	Steel	Zinc
NHSTS8332	2.25	.93	None	Stainless	None
8332-32	2.25	.93	.130	Stainless	None
NHPS8333	3.93	1.03	None	Steel	None
8333-02	3.93	1.03	.195	Steel	Zinc
NHSTS8333	3.93	1.03	None	Stainless	None
8333-32	3.93	1.03	.195	Stainless	None
NHPS8335	3.81	1.26	None	Steel	None
8335-02	3.81	1.26	.218	Steel	Zinc
NHSTS8335	3.81	1.26	None	Stainless	None
8335-32	3.81	1.26	.218	Stainless	None

NONMAGNETIC TENSION CATCHES - SOLID EXTRUDED BRASS

Part No.	Length	Width	Projection	Finishes
1*	1.86	.31	.51	04, 26D
2*	2.15	.43	.60	04, 26D
3*	3.10	.75	.88	04, 26D

* Solid extruded brass with screws at top and bottom provides an adjustable tension feature. Rust-proof bronze balls and stainless springs.

** Cast brass construction with adjusting screws, chrome-plated balls and steel springs.

ELECTRO-POLISHED STAINLESS STEEL HASPS & STAPLES

Part No.	Slotted Arm Length	Pad Length	Pin Length	Gauge	Holes	Use Staple No.
NHSTS91125	2.50	1.12	1.00	.072	None	NHSTS9132
NHSTS91135	3.50	1.34	1.50	.077	None	NHSTS9133
NHSTS91145	4.50	2.25	1.50	.089	None	NHSTS9133
NHSTS91160	6.00	2.75	1.88	.107	None	NHSTS9133
STS91125	2.50	1.12	1.00	.072	#6 ctsk	STS9132
STS91135	3.50	1.34	1.50	.077	#8 ctsk	STS9133
STS91145	4.50	2.25	1.50	.089	#8 ctsk	STS9133
STS91160	6.00	2.75	1.88	.107	#10 ctsk	STS9133
STS912	2.81	0.75	1.12	.060	#8 ctsk	STS914



Stainless Steel and Aluminum, Hasps No. STS911 & AL911

Staple No. STS913



Stainless Steel, Hasp No. STS912

Staple No. STS914

ALUMINUM HASPS & STAPLES

Part No.	Slotted Arm Length	Pad Length	Pin Length	Gauge	Holes	Use Staple No.
AL91135	3.50	1.34	1.50	.077	#8 ctsk	STS9133



Plain Steel, Hasp No. NHPS91135

Staple No. NHPS9133

PLAIN STEEL HASPS & STAPLES

Part No.	Slotted Arm Length	Pad Length	Pin Length	Gauge	Holes	Use Staple No.
NHPS91135	3.34	1.34	1.50	.077	None	NHPS9133
NHPS625	1.63	.50	1.00	.042	None	NHPS626
NHPS825	1.88	.63	1.12	.058	None	NHPS626



Plain Steel, Welding Hasps No. NHPS625 & NHPS825

Staple No. NHPS626

* Hasps and Staples are sold separately.

SLAM LATCHES

Item	Material	Finish	Overall	Height	Width	Pin
9601-02	9601 Steel Slam Latch	Zinc Plated	2.870	1.000	1.250	.375
9601-32	9601 Stainless Slam Latch	Passivated	2.870	1.000	1.250	.375
9602-02	9602 Steel Slam Latch	Zinc Plated	3.750	1.250	1.625	.437
9603-02	9603 Steel Slam Latch	Zinc Plated	4.875	1.375	2.000	.500

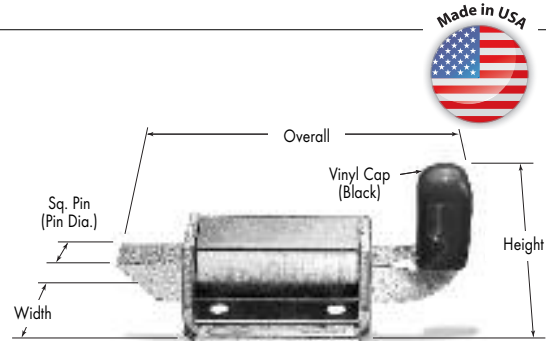

SNAP-IN MAGNETIC CATCHES

Part No.	Width	Depth	Width of Magnet	No. of Magnets
8320-MAG	1.12	.81	.32	1
8321-MAG	1.12	.85	.55	2



No. 8320-MAG



No. 8321-MAG

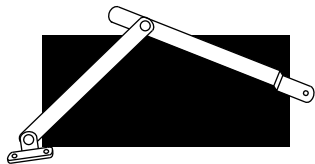

LID SUPPORTS

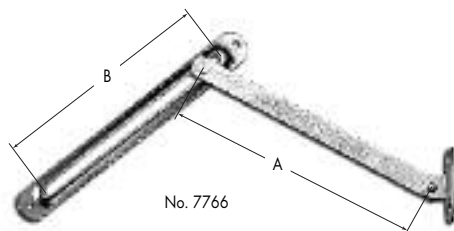

REVERSIBLE LID SUPPORTS

Part No.	Arm Length C to C (A)	Thickness	Slotted Arm Length (B)	Thickness	Finish
7766 RV	5.25	.050	5.71	.050	14

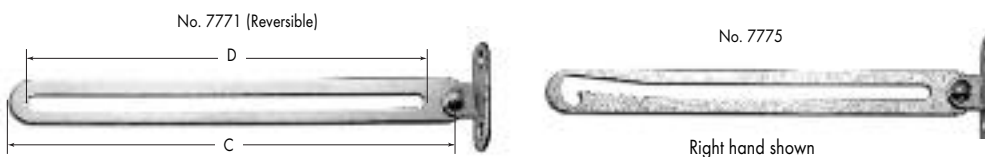

FALL SUPPORTS

Part No.	Overall Length (C)	Width	Thickness	Slot Length (D)	Finish
7771 RV	6.63	.63	.062	5.75	14
7775 RH or LH	6.22	.63	.062	5.38	14

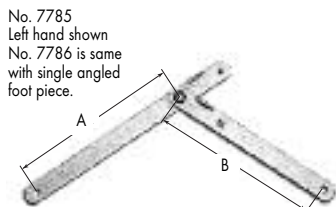

No. 7785
Left hand shown
No. 7786 is same
with single angled
foot piece.

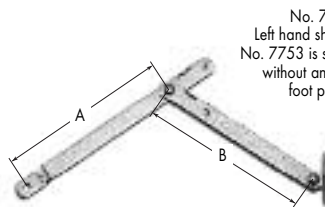

No. 7752
Left hand shown
No. 7753 is same
without angled
foot piece.



LID SUPPORTS

Part No.	Thickness	Width	A	B	Finish
7752 RH or LH	.093	.50	4.88	4.88	14
7753 RH or LH	.093	.50	4.88	4.88	14
7785 RH or LH	.062	.50	4.44	4.44	14

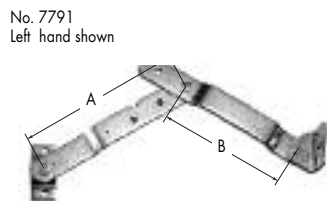

No. 7791
Left hand shown

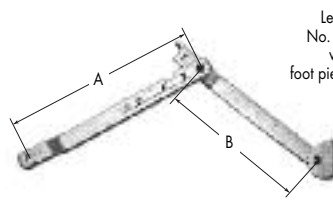

No. 7792
Left hand shown
No. 7793 is same
without angled
foot piece and offset.

TABLE LEG SUPPORTS

Part No.	Thickness	Width	A	B	Finish
7791 RH or LH	.146	1.25	8.41	6.59	02
7792 RH or LH	.109	.64	7.05	5.45	02
7793 RH or LH	.109	.64	7.15	5.40	02

Note: Specify Part No. with RV for reversible (where applicable) or LH, RH for left- or right-handed, then a dash with the finish number, i.e., 7775RH-14.

800-3-HINGES • FAX 631-737-2933 • GUDEN.COM



WWW.GUDEN.COM

VISIT GUDEN ON THE WEB

Be sure to visit Guden.com for all the latest updates and specifications on Guden hinges, gas springs, latches and handles. Plus you can download design forms, drawings and technical guides, and easily purchase items online with your credit card.

The screenshot shows the Guden website homepage. At the top left is the Guden logo with the tagline "WHEN HARDWARE HINGES ON SERVICE". To the right is a navigation bar with links for "About Us", "Stock Products", "Custom Products", "Services", and "Contact Us". A central banner features the text "Your distribution and customization experts for..." followed by "HINGES CATCHES GAS SPRINGS HANDLES" and the phone number "800-3-HINGES". Below the banner is a video player showing a person working at a computer. On the left side, there is a "My Account" menu with links for "Catalog Download", "3D CAD Models", and "Products" (including Hinges, Gas Springs, Handles & Pulls, Catches & Latches, Medical / Marine, and Lid Supports). Below this is a "Knowledge Base" search box. The main content area includes a "News" section with articles like "Guden Goes Green Paperless System Saves Trees and Time", "Guden Introduces Intuitive Product Video Series", and "Guden Answers Your Question as New Customer Service Manager". There is also a "Free Release" and "Newsletters" section. On the right, the "Our Services" section lists "CAD Models", "Customization", "Design Forms", and "Knowledge Base", with a "Find by Dimension" link and a 3D CAD model of a hinge.

SALES TERMS AND CONDITIONS

The products you order from H. A. Guden Co., Inc. will be delivered free from defects in material and workmanship and in accordance with your print specifications. If you experience any problem with any Guden product, please contact your Customer Service Representative for a prompt resolution.

Liberal return policy: If, for any reason, your requirements for a Guden stock inventory item should change, contact your Customer Service Representative. Whether the change is due to a revision of specifications, size, quantity or delivery schedule, Guden will endeavor to accommodate your revisions promptly and courteously.

Credit: Orders will be shipped on an open-account basis to firms with a satisfactory credit rating. Firms without a published rating should submit a completed credit reference application. To expedite your initial order, you may pay via credit card, or send payment in advance until credit can be established.

Terms: Our normal payment terms are net 30 days from date of invoice, upon approval.

Freight: All shipments are F.O.B. our plant in Ronkonkoma, LI, NY. Our shipping department will route via the least costly and most reliable carriers in the event that you do not designate one.

For your convenience, we welcome the American Express® Corporate Card, MasterCard, VISA and Discover.



Dial Toll-Free from anywhere: **800-3-HINGES** (800-344-6437)

631-737-2900, Fax: 631-737-2933 • www.guden.com • info@guden.com

Mission Statement

"The H.A. Guden Co., Inc. will carry an enormous selection of metal cabinet hinges, gas springs, and associated hardware, to deliver products at the demand of our customers. We will guide our customers through the specification, customization and sales processes by offering the most knowledgeable and friendliest service in the industry. Customers will be offered competitive pricing and flexible purchasing programs."



H. A. Guden Co., Inc.
99 Raynor Avenue
Ronkonkoma, NY 11779-6634
800-3-HINGES • 631-737-2900
Fax: 631-737-2933
www.guden.com • info@guden.com